

2020 Catalog

inVenting solutions[™]



Builder's Best

2 Find your venting solutions on these pages:

3 Semi Rigid

Builder's Best
Snap Lock, E-Z-
Fasten, Readi-Pipe,
V250-TD Plain



12 Dryer Vent Kits

Over-The-Top®,
Installers,
Close Loop



23 Wall Vents

Aluminum,
Wide Mouth,
Standard, Trim
Plates



4 Semi Rigid

UL® V750,
UL® V350-
Uncompressed &
V250 Compressed



13 Dryer Outlet Box

Reclaim space in
the wall



24 Wall Vents

Aluminum,
Wide Mouth
Heavy Gauge

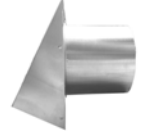

5 Semi Rigid

Model A100
Uncompressed
& Compressed,
V730, V620



14 Foil Hose

Foil, ULTD,
Indoor Lint Traps



26 Wall Vents

Galvanized
Wide Mouth
P-Tanium™
Heavy Gauge

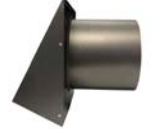

6 Semi Rigid

PRO Crimped &
Plain V330, V331,
V230



16 Vinyl Hose

Vinyl, ClearDuct,
Bath Kits



27 Wall Vents

Galvanized
P-Tanium™



7 Semi Rigid

Crimped & Plain
V320, V321, V220



17 Eave Vents Aluminum

Builders Best,
Micro Louver



28 Wall Vents

Galvanize,
Wide Mouth
Spangled
Heavy Gauge



8 Semi Rigid

Insulated A300
R4, R6 & R8



18 Mini Louver

RDV, EVE, Mini
Louver, SV28,
PEV320, SV



29 Wall Vents

Galvanized
Spangled



9 Duct Connectors

Extensions,
Couplers



20 Roof Vents Aluminum

Aluminum



30 Wall Vents

SM, WC,
J Block



9 Rigid Duct

Aluminum &
Galvanized



21 Roof Vents Galvanized

Galvanized



31 Wall Vents

Plastic
Wide Mouth
Pest Guards



10 Pericopes

0-5, 0-18, 18-29,
29-50, In-wall,
Extensions



22 Roof Vents Plastic

Plastic



32 Wall Vents

Plastic
Louvered



11 Elbows

Specialty:
Close Elbow®,
Offset Elbow®



22 Wall Vents Rectangular

Rectangular



34 Accessories

Foil Tape,
Clamps, Draft
Stopper, Dryer
Heat Diverter



Builder's Best® Snap-Lock™

- Best choice for dryer venting, trusted by professional installers for 30 years
- 4" Aluminum Snap-Lock™ Fittings make installations easier
- One male (crimped) fitting, one female (slotted) fitting



V850-TD

Dia.	Length	Listing	Each #	Qty	Case #	Package
4"	6'	UL@ 2158A	10548	12	110548	Bulk

V830

Dia.	Length	Listing	Each #	Qty	Case #	Package
4"	6'		10129	12	110129	Display Bag
4"	6'		10005	12	010016	Display Tray
4"	5'		10138	15	110138	Bulk
4"	6'		10107	12	110107	Bulk
4"	8'		10120	20	110120	Bulk
4"	12'		10079	20	110079	Bulk

E-Z-Fasten™

- Excellent choice for dryer venting, trusted by professional installers for 30 years
- One male (crimped) fitting, one soft-cuff end



V550-TD

Dia.	Length	Listing	Each #	Qty	Case #	Package
4"	8'	UL@ 2158A	10546	12	110546	Bulk

V530

Dia.	Length	Listing	Each #	Qty	Case #	Package
4"	5'		10130	5	110130	Display Bag
4"	5'		10130	15	010150	Display Bag
4"	5'		10105	15	110105	Bulk
4"	8'		10180	20	110180	Bulk
4"	2'		10160	30	110160	Bulk

Readi-Pipe™

- Soft cuff ends are ready to clamp to other components



V450-TD

Dia.	Length	Clamps	Listing	Each #	Qty	Case #	Package
4"	6'		UL@ 2158A	11700	12	111700	Bulk
4"	8'		UL@ 2158A	10545	12	110545	Bulk
4"	8'	2 steel screw	UL@ 2158A	12102	12	112102	Display Bag

V430

Dia.	Length	Clamps	Listing	Each #	Qty	Case #	Package
4"	4'			10088	20	110088	Bulk
4"	5'			10089	15	110089	Bulk
4"	6'			10090	12	110090	Bulk
4"	8'			10091	12	110091	Bulk
4"	8'	2 steel screw		10131	12	110131	Display Bag

V250-TD Plain End

- UL 2158A listed
- Plain ends

Dia.	Length	Listing	Each #	Qty	Case #	Package
4"	8'	UL@ 2158A	10592	12	110592	Bulk



A250-TD Plain End A Seam™

- UL 2158A listed
- Plain ends
- unique compression takes less space
- Patent Pending

Dia.	Length	Listing	Each #	Qty	Case #	Package	Note
4"	8'	UL@ 2158A	12103	12	112103	Display Bag	Regional Availability

4 Semi-Rigid Flexible Aluminum Air Duct - UL® Labeled

V750 Metalflex® Air Duct

- Universal male/female collar on each end
- 8' pieces compressed to 32"
- Factory installed universal male/female collars ensure uniform, air tight connections
- UL® 181 label

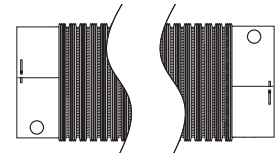

Dia.	Length	Each #	Qty	Case #	Package
5"	8'	10344	9	110344	Bulk
6"	8'	10345	4	110345	Bulk
7"	8'	10347	4	110347	Bulk
8"	8'	10348	4	110348	Bulk
9"	8'	10350	4	110350	Bulk
10"	8'	10351	4	110351	Bulk
12"	8'	10352	1	010352	Ind. Box
14"	8'	10353	1	010353	Ind. Box
16"	8'	10354	1	010354	Ind. Box
18"	8'	10355	1	010355	Ind. Box
20"	8'	10356	1	010356	Ind. Box
22"	8'	10357	1	010357	Ind. Box
24"	8'	10358	1	010358	Ind. Box

V350-U Metalflex® Air Duct

- Un-compressed 8' length
- One end crimped, one end plain
- UL® 181 label

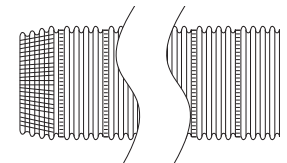

Dia.	Length	Each #	Qty	Case #	Package	Note
3"	8'	10744	42	110744	Bulk	Regional Availability
4"	8'	10745	25	110745	Bulk	Regional Availability
5"	8'	10759	16	110759	Bulk	Regional Availability
6"	8'	10760	12	110760	Bulk	Regional Availability
7"	8'	10761	9	110761	Bulk	Regional Availability
8"	8'	10762	6	110762	Bulk	Regional Availability
9"	8'	10763	5	110763	Bulk	Regional Availability
10"	8'	10764	4	110764	Bulk	Regional Availability
12"	8'	10755	2	110755	Bulk	Regional Availability

V250 Metalflex® Air Duct

- Plain Ends
- Compressed
- UL® 181 label

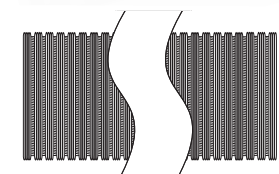

Dia.	Length	Each #	Qty	Case #	Package
3"	8'	10803	56	110803	Bulk
3"	10'	10801	40	110801	Bulk
4"	8'	10804	30	110804	Bulk
4"	10'	10802	24	110802	Bulk
5"	8'	10805	15	110805	Bulk
5"	10'	10690	15	110690	Bulk
6"	8'	10806	12	110806	Bulk
6"	10'	10691	12	110691	Bulk
7"	8'	10807	8	110807	Bulk
7"	10'	10692	6	110692	Bulk
8"	8'	10808	6	110808	Bulk
8"	10'	10693	6	110693	Bulk
9"	8'	10809	5	110809	Bulk
10"	8'	10810	4	110810	Bulk



Model A100-U Thermofin® Air Duct

- Uncompressed 8' lengths
- Factory crimp on one end
- UL® 181 label



Dia.	Length	Each #	Qty	Case #	Package	Note
3"	8'	11253	42	111253	Bulk	Regional Availability
4"	8'	11254	25	111254	Bulk	Regional Availability
5"	8'	11255	16	111255	Bulk	Regional Availability
6"	8'	11256	12	111256	Bulk	Regional Availability
7"	8'	11257	9	111257	Bulk	Regional Availability
8"	8'	11258	6	111258	Bulk	Regional Availability
9"	8'	11259	5	111259	Bulk	Regional Availability
10"	8'	11260	4	111260	Bulk	Regional Availability
12"	8'	11261	4	111261	Bulk	Regional Availability
14"	8'	11262	4	111262	Bulk	Regional Availability
16"	8'	11263	1	011263	Ind. Box	Regional Availability
18"	8'	11264	1	011264	Ind. Box	Regional Availability
20"	8'	11265	1	011265	Ind. Box	Regional Availability
24"	8'	11266	1	011266	Ind. Box	Regional Availability

Model A100 Stretch-Fit™ Thermofin® Air Duct

- 8' lengths compressed to 29"
- Factory crimp on one end
- UL® 181 label



Dia.	Length	Each #	Qty	Case #	Package	Note
3"	8'	11356	12	111356	Bulk	Regional Availability
4"	8'	11357	8	111357	Bulk	Regional Availability
5"	8'	11358	5	111358	Bulk	Regional Availability
6"	8'	11270	8	111270	Bulk	Regional Availability
7"	8'	11271	6	111271	Bulk	Regional Availability
8"	8'	11272	4	111272	Bulk	Regional Availability
9"	8'	11273	4	111273	Bulk	Regional Availability
10"	8'	11274	3	111274	Bulk	Regional Availability
12"	8'	12398	1	012398	Bulk	Regional Availability

Semi-Rigid Flexible Aluminum Duct - Non-Labeled

V730 Double Female Ends

- Aluminum female collars overlap for smooth seams

Dia.	Length	Clamps	Each #	Qty	Case #	Package
3"	8'	n/a	10300	20	011454	Bulk
4"	8'	n/a	10304	12	011456	Bulk
3"	8'	2 steel screw	10303	20	011501	Bulk
4"	8'	2 steel screw	10307	12	011502	Bulk

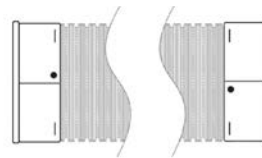

V620 Push Fit™

- Aluminum collars overlap for smooth seams

Dia.	Length	Each #	Qty	Case #	Package
4"	2'	11564	12	111564	Bulk
4"	4'	10550	15	110550	Bulk
4"	8'	10551	12	110551	Bulk



A220 ASeam™

- Class 0 duct for general use with unique compression taking less space in warehouse and on trucks.
- Plain Ends • Patent Pending

Dia.	Length	Each	Qty	Case #	Package	Note
3"	10'	12903	20	112903	Bulk	Regional Availability
4"	10'	12911	12	112911	Bulk	Regional Availability



6 Semi Rigid-Flexible Aluminum Duct - Non-Labeled

Class 0 metal duct, non-insulated general purpose venting for low and medium operating pressures, non-combustible corrugated aluminum with water-tight continuous lockseams

V330 PRO

- One crimped end and one plain end

Dia.	Length	Each #	Qty	Case #	Package
3"	8'	10308	20	011489	Bulk
4"	8'	10312	12	011491	Bulk
5"	8'	10316	6	011493	Bulk
6"	8'	10317	4	110317	Bulk
7"	8'	10319	4	110319	Bulk
8"	8'	10320	4	110320	Bulk
9"	8'	10322	4	110322	Bulk
10"	8'	10323	4	110323	Bulk
12"	8'	10246	4	110246	Bulk
14"	8'	11393	2	111393	Bulk

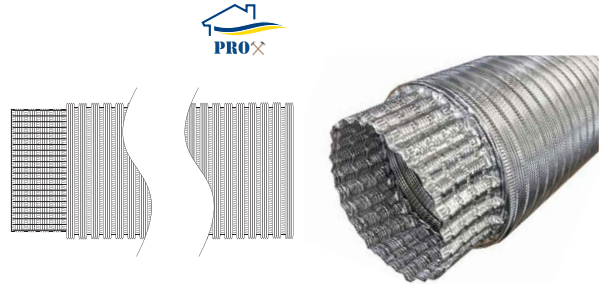

V331 PRO

- Same as V330 but with a double crimp on one end

Dia.	Length	Each	Qty	Case #	Package
3"	8'	10581	20	011450	Bulk
4"	8'	10582	12	011452	Bulk

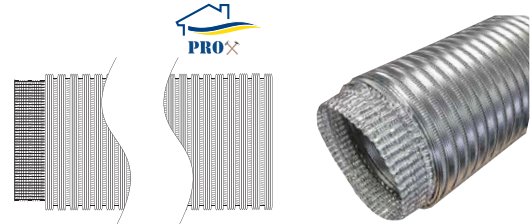

V230 PRO

- Same as V330 above but with plain ends

Dia.	Length	Clamps	Each #	Qty	Case #	Package
3"	8'		10250	20	110250	Bulk
3"	10'		10251	20	110251	Bulk
3"	20'		10401	25	110401	Bulk
3"	25'		10252	25	110252	Bulk
4"	8'		10087	12	110087	Bulk
4"	10'		10253	12	110253	Bulk
4"	20'		10402	16	110402	Bulk
4"	25'		10315	16	110315	Bulk
5"	8'		10255	6	011476	Bulk
5"	10'		10256	9	110256	Bulk
5"	20'		10257	9	110257	Bulk
6"	8'		10258	4	011479	Bulk
6"	10'		10259	12	110259	Bulk
6"	20'		10260	6	110260	Bulk
7"	8'		10261	4	011482	Bulk
7"	10'		10262	8	110262	Bulk
7"	20'		10263	4	110263	Bulk
8"	8'		10264	4	110264	Bulk
8"	10'		10265	6	011487	Bulk
8"	20'		10266	4	110266	Bulk
9"	8'		10267	4	110267	Bulk
9"	10'		10268	4	110268	Bulk
9"	20'		10269	4	110269	Bulk
10"	8'		10383	4	110383	Bulk
10"	10'		10384	4	110384	Bulk
10"	20'		10385	4	110385	Bulk
12"	8'		10247	4	110247	Bulk
14"	8'		10248	2	110248	Bulk
4"	8'	2 steel screw	10460	12	110460	Display Bag

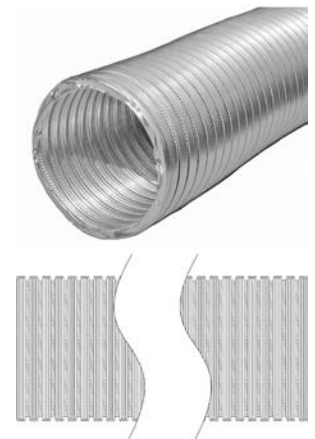

V330 and V230 have thicker walls than the V320 and the V220



V320

- One crimped end and one plain end (lighter version of V330)

Dia.	Length	Each #	Qty	Case #	Package
3"	8'	10443	10	110443	Display Bag
3"	8'	10433	20	011458	Bulk
4"	8'	10444	12	110444	Display Bag
4"	8'	10434	12	110434	Bulk
4"	20'	10439	16	110439	Bulk
5"	8'	10445	6	110445	Display Bag
5"	8'	10435	6	110435	Bulk
6"	8'	10446	4	011463	Display Bag
6"	8'	10436	4	010431	Bulk
7"	8'	10447	4	011465	Display Bag
7"	8'	10437	4	011466	Bulk
8"	8'	10448	4	011468	Display Bag
8"	8'	10438	4	011469	Bulk

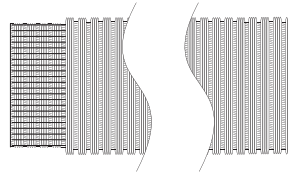

V321

- Same as V320 above but with a double crimp on one end (lighter version of V331)

Dia.	Length	Each #	Qty	Case #	Package
3"	8'	10583	20	011471	Bulk
4"	8'	10584	12	110584	Bulk
5"	8'	10585	6	110585	Bulk
6"	8'	10586	4	011473	Bulk
7"	8'	10587	4	011474	Bulk
8"	8'	10588	4	011475	Bulk

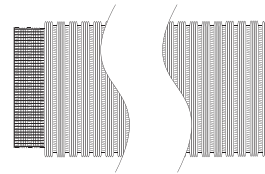

V220

- Same as V320 above but with Plain Ends (lighter version of V320)

Dia.	Length	Clamps	Each #	Qty	Case #	Package
3"	8'		10453	10	110453	Display Bag
3"	8'		11583	10	111583	Display Tag
3"	8'		10403	20	011436	Bulk
3"	10'		10413	20	110413	Bulk
3"	20'		10420	25	110420	Bulk
3"	25'		10421	25	110421	Bulk
4"	5'		10400	15	110400	Bulk
4"	8'		10454	12	110454	Display Bag
4"	8'		11584	12	111584	Display Tag
4"	8'		10404	12	110404	Bulk
4"	10'		10414	12	110414	Bulk
4"	20'		10429	16	110429	Bulk
4"	25'		10419	16	110419	Bulk
5"	8'		11585	6	111585	Display Tag
5"	8'		10405	6	110405	Bulk
5"	10'		10415	9	011440	Bulk
5"	20'		10425	9	110425	Bulk
6"	8'		11586	4	111586	Display Tag
6"	8'		10406	4	011441	Bulk
6"	10'		10416	12	110416	Bulk
6"	10'		10822	12	110822	Display Tag
6"	20'		10426	6	011443	Bulk
7"	8'		11587	4	111587	Display Tag
7"	8'		10407	4	011444	Bulk
7"	10'		10417	8	110417	Bulk
7"	10'		10823	8	110823	Display Tag
8"	8'		11588	4	111588	Display Tag
8"	8'		10408	4	011447	Bulk
8"	10'		10418	6	110418	Bulk
8"	10'		10824	6	110824	Display Tag
4"	8'	2 steel screw	10459	12	110459	Display Bag

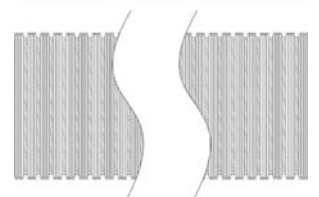

See Pg 3 V250-TD
UL® 2158A version
Plain Ended Pipe

See pg 5 A220 A-Seam™
Tighter compression
Patent Pending



8 Semi-Rigid Flexible Aluminum Duct - UL® Labeled

Model A300 Thermofin® Insulated Air Duct

- Uncompressed 8' lengths
- Factory crimp on one end
- Insulated - R4, R6, R8
- Outer jacket is silver "metalized" with scrim mylar vapor barrier.
- UL® 181 label



A300 R4

Dia.	Length	Each #	Qty	Case #	Package	Note
4"	8'	11307	12	111307	Bulk	Regional Availability
5"	8'	11308	9	111308	Bulk	Regional Availability
6"	8'	11309	8	111309	Bulk	Regional Availability
7"	8'	11310	5	111310	Bulk	Regional Availability
8"	8'	11311	4	111311	Bulk	Regional Availability
9"	8'	11312	4	111312	Bulk	Regional Availability
10"	8'	11313	4	111313	Bulk	Regional Availability
12"	8'	11314	4	111314	Bulk	Regional Availability
14"	8'	11315	3	111315	Bulk	Regional Availability
16"	8'	11316	1	011316	Ind. Box	Regional Availability
18"	8'	11317	1	011317	Ind. Box	Regional Availability
20"	8'	11318	1	011318	Ind. Box	Regional Availability



A300 R6

Dia.	Length	Each #	Qty	Case #	Package	Note
3"	8'	11320	16	111320	Bulk	Regional Availability
4"	8'	11321	12	111321	Bulk	Regional Availability
5"	8'	11322	9	111322	Bulk	Regional Availability
6"	8'	11323	6	111323	Bulk	Regional Availability
7"	8'	11324	4	111324	Bulk	Regional Availability
8"	8'	11325	4	111325	Bulk	Regional Availability
9"	8'	11326	4	111326	Bulk	Regional Availability
10"	8'	11327	4	111327	Bulk	Regional Availability
12"	8'	11328	3	111328	Bulk	Regional Availability
14"	8'	11329	2	111329	Bulk	Regional Availability
16"	8'	11330	1	011330	Ind. Box	Regional Availability
18"	8'	11331	1	011331	Ind. Box	Regional Availability
20"	8'	11332	1	011332	Ind. Box	Regional Availability

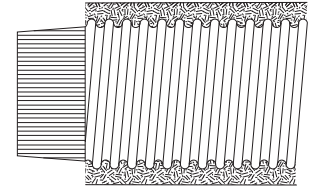

A300 R8

Dia.	Length	Each #	Qty	Case #	Package	Note
3"	8'	11661	16	111661	Bulk	Regional Availability
4"	8'	11662	12	111662	Bulk	Regional Availability
5"	8'	11663	9	111663	Bulk	Regional Availability
6"	8'	11664	6	111664	Bulk	Regional Availability
7"	8'	11665	4	111665	Bulk	Regional Availability
8"	8'	11666	4	111666	Bulk	Regional Availability
9"	8'	11667	4	111667	Bulk	Regional Availability
10"	8'	11668	4	111668	Bulk	Regional Availability
12"	8'	11669	3	111669	Bulk	Regional Availability
14"	8'	11670	2	111670	Bulk	Regional Availability
16"	8'	11671	1	011671	Ind. Box	Regional Availability
18"	8'	11672	1	011672	Ind. Box	Regional Availability
20"	8'	11673	1	011673	Ind. Box	Regional Availability



Aluminum Extension Collar

- 4" Dia. x 3" long aluminum collar with snap-lock fittings
- Designed to extend the reach of Snap-Lock™ collars
- Can be used with Close Elbow®, Offset Elbows and periscope collars



Dia.	Length	Description	Each #	Qty	Case #	Package
4"	3.25"	one end crimped, one end slotted	10103	25	110103	Bulk

Aluminum Duct Collar/Coupler

- Aluminum coupling to connect pieces of pipe
- Crimped & hemmed end on 10490, 10491 and 11536 is designed to help prevent duct from sliding off

Dia.	Length	Description	Each #	Qty	Case #	Package
3"	3"	both ends crimped & hemmed	10490	12	110490	Bulk
4"	3"	both ends crimped & hemmed	10491	12	110491	Bulk
6"	3"	both ends crimped & hemmed	11536	6	111536	Bulk
4"	2.25"	one end crimped, one end beaded	10137	25	110137	Bulk



110137



110490,
110491 & 111536

Galvanized Duct Collar/Coupler

- Galvanized coupling
- Connect pieces of pipe, hemmed ends help prevent duct from sliding off

Dia.	Length	Description	Each #	Qty	Case #	Package
3"	4"	both ends crimped	11689	16	111689	Bulk
4"	4"	both ends crimped	11690	9	111690	Bulk
6"	4"	both ends crimped	11691	4	111691	Bulk

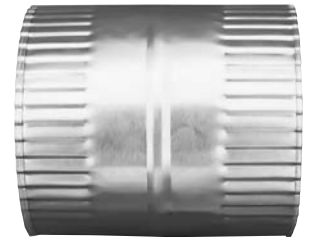

Increaser & Reducer

- Connect ducts of different diameters

Dia.	Description	Each #	Qty	Case #	Package
3-4"	Aluminum increaser 3" to 4"	10493	12	110493	Bulk
4-3"	Aluminum reducer 4" to 3"	10492	12	110492	Bulk
3-4"	Plastic increaser/reducer 3" to 4"	10290	10	110290	Bulk



110493



10492



110290

Rigid Duct - Round

Rigid Pipe

- One crimped end and one plain end
- Galvanized, V030 Heavy aluminum, V020 mid-weight aluminum, V010 lightest weight aluminum
- Ships nested, secure on-site with Reeves-Lock snap-together assembly

Dia.	Length	Description	Material	Each #	Qty	Case #	Package
3"	5'	Rigid Pipe	Galvanized 30 gauge	11372	15	111372	Bulk
4"	2'	Rigid Pipe	Galvanized 30 gauge	10182	25	110182	Bulk
4"	5'	Rigid Pipe	Galvanized 30 gauge	11002	15	111002	Bulk
4"	2'	V030	Aluminum 26 gauge	10642	25	110642	Bulk
4"	5'	V030	Aluminum 26 gauge	10643	15	110643	Bulk
3"	2'	V020	Aluminum 30 gauge	10636	25	110636	Bulk
3"	5'	V020	Aluminum 30 gauge	10637	15	110637	Bulk
4"	2'	V020	Aluminum 30 gauge	10638	25	110638	Bulk
4"	5'	V020	Aluminum 30 gauge	10639	15	110639	Bulk
3"	2'	V010	Aluminum 32 gauge	10644	25	110644	Bulk
4"	2'	V010	Aluminum 32 gauge	10645	25	110645	Bulk



Reeves Lock

10 Rigid Duct - Periscopes

Zero Periscope™

- Available in 0-5 and 0-18 lengths
- Use where outlets overlap or are very close
- Baffles help direct airflow in 3-5" situations
- Sections are not reversible

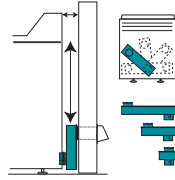

18-29" Periscope

- Reaches side of most dryers
- Two piece assembly
- Sections are reversible for airflow the same or opposite

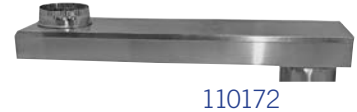
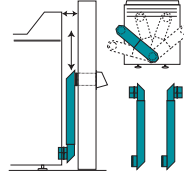

29-50" Periscope

- Reaches top of most dryers
- Four piece assembly
- Sections are reversible for airflow the same or opposite

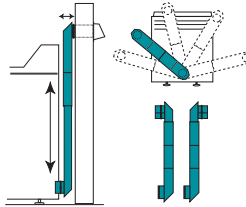

Extension pieces

- 2" x 6" rigid metal with no fittings
- Slide into and over 18-29, 29-50 and 29-74" sections to lengthen.
- Use aluminum tape to secure the sections

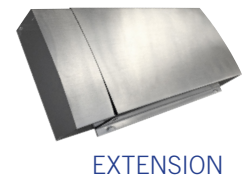

Dia.	Length	Note	Each #	Qty	Case #	Package
4"	0-5"	with baffle	10175	9	110175	Display Card
4"	0-5"	no baffle	10144	9	110144	Bulk
4"	0-5"	no baffle	10149	9	110149	Ind. Box
4"	0-18"	with baffle	10172	4	110172	Display Box
4"	0-18"	with baffle	10128	4	110128	Display Bag
4"	0-18"	with baffle	10128	8	010158	Display Bag
4"	0-18"	with baffle	10146	8	110146	Bulk
4"	0-18"	with baffle	10148	4	110148	Ind. Box
4"	0-18"	UL® with baffle	12276	4	112276	Ind. Box
4"	18-29"		10173	4	110173	Display Box
4"	18-29"		10133	4	110133	Display Bag
4"	18-29"		10133	9	010153	Display Bag
4"	18-29"		10114	9	110114	Bulk
4"	18-29"		10116	4	110116	Ind. Box
4"	18-29"	UL®2158A	12277	4	112277	Ind. Box
4"	29-50"		10174	4	110174	Display Box
4"	29-50"		10117	4	110117	Ind. Box
n/a	23"	extension	10141	8	110141	Bulk
n/a	43"	extension	10142	8	110142	Bulk

- Periscopes:
- 2" x 6" rigid aluminum
 - Telescoping length
 - Close clearance

In-Wall Periscope / Rough-In Systems

- Four telescoping sections
- Standard 4" diameter fittings, one male snap-lock and one female snap-lock
- Mounting strap included



Dia.	Length	Material	Each #	Qty	Case #	Package
4"	29"-72"	30 ga. Galvanized	10868	3	110868	Ind. Box
4"	52"-95"	30 ga. Galvanized	10869	3	110869	Ind. Box
4"	29"-72"	26 ga. Aluminum	10094	3	110094	Display Box
4"	29"-72"	26 ga. Aluminum	10140	3	110140	Ind. Box

Close Elbow®

- Aluminum 90° elbow turns 90° within 4"
- Best choice for 90° turns, especially on the dryer
- Rotating snap-lock collars connect without clamps to other snap-lock collars



Dia.	Note	Collar 1	Collar 2	Each #	Qty	Case #	Package
4"		male (crimped)	female (slotted)	10161	6	110161	Display Card
4"		male (crimped)	female (slotted)	10161	24	010151	Display Card
4"	1 clamp	male (crimped)	female (slotted)	10108	24	110108	Bulk
4"	UL® 2158A	male (crimped)	female (slotted)	12270	24	112270	Bulk

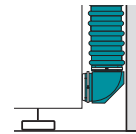

Wall Offset Elbow®

- Aluminum 90° elbow turns 90° within 4"
- Snap-lock collars connect without clamps to other snap-lock collars
- Use when outlet pipe in wall protrudes up to 2.5" and cannot be trimmed

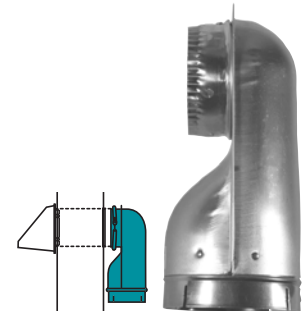

Dia.	Collar 1	Collar 2	Each #	Qty	Case #	Package
4"	male rotates	female (slotted)	10162	4	110162	Display Card
4"	male rotates	female (slotted)	10162	20	010152	Display Card
4"	male rotates	female (slotted)	10109	20	110109	Bulk

Dryer Offset Elbow®

- Aluminum 90° elbow turns 90° within 4"
- Snap-lock collars connect without clamps to other snap-lock collars
- Use when outlet pipe on dryer protrudes up to 2.5" and cannot be trimmed
- Can also be used on wall outlet pipe if pipe is too large for Wall Offset Elbow

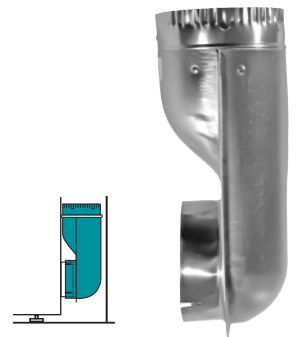

Dia.	Collar 1	Collar 2	Each #	Qty	Case #	Package
4"	male (crimped)	female rotates	10165	4	110165	Display Card
4"	male (crimped)	female rotates	10165	20	010155	Display Card
4"	male (crimped)	female rotates	10110	20	110110	Bulk

Standard Elbow

- One crimped end and one plain end
- 4-piece sectional adjustability
- Standard elbows turn 90° within 6"
- Long Sweep Elbow measures the same as straight pipe helps overcome length of run issues

Dia.	Description	Material	Each #	Qty	Case #	Package
3"	Standard Elbow	Galvanized 30 gauge	10184	12	110184	Bulk
3"	Standard Elbow	Galvanized 30 gauge	10184	900	010186	Skid (75 cases)
4"	Standard Elbow	Galvanized 30 gauge	10181	12	110181	Bulk
4"	Standard Elbow	Galvanized 30 gauge	10181	660	010187	Skid (55 cases)
6"	Standard Elbow	Galvanized 30 gauge	12339	6	112339	Bulk
4"	Standard Elbow	Aluminum 26 gauge	10544	12	110544	Bulk
4"	Long Sweep Elbow	Galvanized 30 gauge	11645	12	111645	Bulk
4"	Long Sweep Elbow	Aluminum 26 gauge	11646	12	111646	Bulk



12 Dryer Vent Kits

Over-The-Top® Snap-Lock™ Dryer Vent Kit

- Installs in 4½", when wall pipe is trimmed flush and wall plate is used. Swivel collars on elbows allow dryer to be pulled away from wall for cleaning without disconnecting. Semi-rigid flexible duct snap-locks together, as final step.

Kit contains:

- Two - 4 ft duct sections attached to two Close Elbows®
- Two - steel screw clamps for wall and dryer connections
- One - wall plate for flush clearance

Dia.	Length	Elbows	Clamps	Each #	Qty	Case #	Package
4"	8'	2 Close Elbows®	2 steel screw	10171	4	110171	Display Box
4"	8'	2 Close Elbows®	2 steel screw	10127	6	110127	Bulk

UL® Listed 2158A version:

4"	8'	2 Close Elbows®	2 steel screw	11920	4	111920	Ind. Box
----	----	-----------------	---------------	-------	---	--------	----------



OVER-THE-TOP®

Installer's Kit™ with Snap-Lock™ Dryer Vent Kit

Wall offset elbow allows the wall pipe to protrude up to 2½" without trimming.

Kit contains:

- One - 4 ft duct section attached to a Close Elbow®
- One - 4 ft duct section attached to a Wall Offset Elbow®
- One - extension collar (for recessed wall pipe)
- Two - steel screw clamps for wall and dryer connection

Dia.	Length	Elbows	Clamps	Each #	Qty	Case #	Package
4"	8'	1 Close, 1 Wall	2 steel screw	10095	4	110095	Ind. Box
4"	8'	1 Close, 1 Wall	2 steel screw	10096	6	110096	Bulk

UL® Listed 2158A version:

4"	8'	1 Close, 1 Wall	2 steel screw	11922	4	111922	Ind. Box
----	----	-----------------	---------------	-------	---	--------	----------



INSTALLER'S KIT

Close Loop™ UL® Listed Dryer Vent Kit

UL® 2158A Listed Kit contains:

- 1 - 6 ft UL® semi-rigid flexible duct
- 2 - Close Elbows®
- 2 - steel screw clamps for wall and dryer connection

Dia.	Length	Elbows	Clamps	Each #	Qty	Case #	Package
4"	6'	2 Close Elbows®	2 steel screw	11693	4	111693	Ind. Box
4"	6'	2 Close Elbows®	2 steel screw	11926	4	111926	Display Box



6' CLOSE LOOP KIT

Single Elbow UL® Listed Dryer Vent Kit

UL® 2158A Listed Kit contains:

- 1 - 8 ft UL® semi-rigid flexible duct
- 1 - Close Elbow®
- 2 - steel screw clamps for wall and dryer connection

Dia.	Length	Elbows	Clamps	Each #	Qty	Case #	Package
4"	8'	1 Close Elbows®	2 steel screw	11718	4	111718	Ind. Box



SINGLE ELBOW KIT



All Metal Dryer Vent Kits with Close Elbows®



110049

Dia.	Length	Pipe	Elbows	Clamps	Each #	Qty	Case #	Package
4"	6'	V830 Builder's Best	2 Close Elbows	2 steel	10043	4	110043	Ind. Box
4"	6'	V430 Readi-Pipe	2 Close Elbows	4 steel	10049	4	110049	Ind. Box
4"	8'	V430 Readi-Pipe	2 Close Elbows	4 steel	10050	4	110050	Ind. Box

All Metal Dryer Vent Kits with Hoods

Hoods have 10" tails and may require assembly



110537

Dia.	Length	Pipe	Hood	Color	Clamps	Each #	Qty	Case #	Package
4"	5'	V230 Plain	AWM320 aluminum wide mouth	silver	2 steel	12101	4	112101	Ind. Box
4"	8'	V230 Plain	AWM320 aluminum wide mouth	silver	2 steel	10536	4	110536	Bulk
4"	8'	V220 Plain	PWM620 plastic wide mouth	white	2 steel	10625	12	110625	Ind. Box
4"	8'	V220 Plain	PWM620 plastic wide mouth	brown	2 steel	10626	12	110626	Ind. Box
4"	8'	V220 Plain	PML320 plastic multi louver	brown	2 steel	12100	6	112100	Ind. Box
4"	8'	V220 Plain	PML320 plastic multi louver	white	2 steel	11405	6	111405	Display Box
4"	5'	V220 Plain	AWM320 aluminum wide mouth	silver	2 steel	10537	4	110537	Display Box

Dryer Outlet Box

Dryer Outlet Box

This dryer outlet box cleanly finishes off dryer vent rough-ins and recaptures space in the wall behind the dryer for venting.

- One Self trimming unit: 18" wide by 24" high
- Fits all 16" centers 2x4's and 2x6's;
- Six patented rip-tab knockouts in most common positions
 - Four true 4" Dia. knockouts (two rear, two right upper and lower)
 - Two 3" x 4.5" oval knockouts (left upper and lower)

Oval knockouts are provided for non-standard connections to existing venting (i.e. squashed duct), or for a round to oval adapter.

- Four starburst knockouts for gas connections and venting
- Six pre-drilled mounting holes
- Plastic meets UL® standard 94 HB tests for flammability
- Six screws included

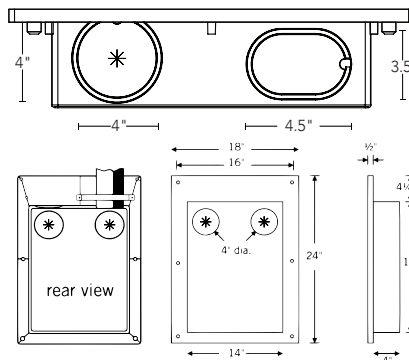

Dryer Outlet Box Kit

Kit Includes:

- One Dryer Outlet Box
- One Aluminum Periscope
- Two rectangle to round transitions

Description	Accessories	Each #	Qty	Case #	Package
Single Box	n/a	10697	10	110697	Bulk
Single Box	n/a	10698	3	110698	Ind. Box
Single Box	n/a	10696	3	110696	Display Box
Single Box	one round to oval adapter	11563	3	111563	Display Box
Kit for 8' Wall	box, periscope, 2 transitions	11000	5	111000	Ind. Box
Kit for 10' wall	box, periscope, 2 transitions	11001	5	111001	Ind. Box
Adapter	aluminum rectangle to round	10518	12	110518	Bulk
Adapter	aluminum round to oval	11396	16	111396	Bulk



110518



111396

14 Wire Helix Hose

Foil Duct

- UL® 181, Class 1 air connector label
- Multi-ply design of metalized polyester and aluminum/polyester laminate
- Steel wire support
- 3" dia. has ¾" pitch; 4–12" dia. has 1" pitch
- UL® sticker every 10 feet
- Maximum velocity rating 5000 fpm



Dia.	Length	Clamps	Each #	Qty	Case #	Package	Special Order
3"	8'		10218	12	110218	Bulk	Special Order
3"	25'		10201	4	110201	Bulk	
3"	25'		10825	16	110825	bag	
3"	25'		10221	5	110221	Ind. Box	
3"	50'		10215	4	110215	Ind. Box	
4"	5'		10219	12	110219	Bulk	
4"	5'		10223	12	110223	Display Box	
4"	8'		10224	12	110224	Display Box	
4"	8'		10220	12	110220	Bulk	
4"	8'		10220	36	010242	Bulk	
4"	25'		10202	4	110202	Bulk	
4"	25'		10826	16	110826	Bag	
4"	25'		10222	5	110222	Ind. Box	
4"	50'		10216	4	110216	Ind. Box	
4"	50'		10244	4	110244	Display Box	
5"	25'		10203	1	010203	Ind. Box	
6"	25'		10204	1	010204	Ind. Box	
7"	25'		10205	1	010205	Ind. Box	Special Order
8"	25'		10206	1	010206	Ind. Box	Special Order
9"	25'		10207	1	010207	Ind. Box	Special Order
10"	25'		10208	1	010208	Ind. Box	Special Order
12"	25'		10210	1	010210	Ind. Box	Special Order
4"	8'	2 spring	10680	12	110680	Bag	
4"	5'	2 steel screw	10660	12	110660	Display Bag	
4"	8'	2 steel screw	10661	12	110661	Display Bag	

Foil Duct:
 • UL® 181 rating
 for HVAC general
 purposes

Foil Duct Wall Vent Kit with Hood

- UL® 181 Foil Duct
- Hood
- Zip Torq™ Clamps



110533

Dia.	Length	Hood	Color	Clamps	Each #	Qty	Case #	Package
4"	5'	PWM620 plastic wide mouth	white	2 Zip Torq™	10620	4	110620	Ind. Box
4"	8'	PWM620 plastic wide mouth	white	2 Zip Torq™	10618	4	110618	Ind. Box
4"	8'	ASM320 aluminum standard mouth	silver	2 Zip Torq™	10533	4	110533	Ind. Box
4"	5'	ASM320 aluminum standard mouth	silver	2 Zip Torq™	10603	4	110603	Ind. Box
4"	5'	PML320 plastic multi louver	brown	2 Zip Torq™	10611	4	110611	Ind. Box
4"	5'	PML320 plastic multi louver	white	2 Zip Torq™	10612	4	110612	Ind. Box
4"	8'	PML320 plastic multi louver	brown	2 Zip Torq™	10609	4	110609	Ind. Box
4"	8'	PML320 plastic multi louver	white	2 Zip Torq™	10610	4	110610	Ind. Box
4"	8'	PML320 plst multi louver & Incr/Red	white	2 Zip Torq™	11520	6	111520	Display Box



111520

Foil Duct Roof Vent Kits

- UL® 181 Foil Duct
- Roof Cap
- Plastic Increaser/Reducer included with Roof Cap Kits



011885

ROOF VENT KIT

Dia.	Length	Hood	Clamps	Each #	Qty	Case #	Package
4"	8'	Duraflo Dryer Roof Cap	2 Zip Torq™	11885	1	011885	Ind. Box
4"	8'	GRV635 Metal Roof Cap	2 Zip Torq™	12640	1	012640	Ind. Box



SilverDuct™

- UL® 2158A listed and labeled as foil dryer transition duct
- Multi-ply design of metalized polyester and aluminum/polyester laminate with steel wire support
- This product is not recommended by Builder's Best as dryer venting
- Check your clothes dryer manufacturer manual as installation may invalidate warranties
- Check local building codes for appropriate use

Long lengths are constructed to meet UL® 2158A. However, there is no UL® label since clothes dryer transition duct venting is only allowed to be 8 feet in length.

Dia.	Length	Clamps	Each #	Qty	Case #	Package
4"	5'		10504	12	110504	Bulk
4"	5'		10504	72	010507	Bulk
4"	5'		10676	6	110676	Display Box
4"	8'		10505	12	110505	Bulk
4"	8'		10505	54	010508	Bulk
4"	8'		10677	6	110677	Display Box
4"	8'		10677	20	010793	Display Box
4"	5'	2 spring	10670	12	110670	bag
4"	8'	2 spring	10671	12	110671	bag
4"	5'	2 ZipTorq™	10672	12	110672	Display Box
4"	8'	2 ZipTorq™	10673	12	110673	Display Box
4"	20'		11506	6	111506	Display Box
4"	25'		11504	5	111504	Ind. Box
4"	50'		11505	4	111505	Ind. Box



Safety Precautions

SilverDuct:

- UL® 2158A rating for clothes dryer venting
- Safety Precautions on website

SilverDuct™ Dryer Vent Kit with Hood

- UL® 2158A Dryer Foil Duct
- Hood
- Zip Torq™ Clamps

Dia.	Length	Hood	Clamps	Each #	Qty	Case #	Package
4"	5'	PML320 plastic multi louver white	2 ZipTorq™	11406	6	111406	Display Box
4"	8'	PML320 plastic multi louver white	2 ZipTorq™	11407	6	111407	Display Box
4"	8'	PWM624 plastic wide mouth bird guard white	2 ZipTorq™	11408	8	111408	Display Box
4"	8'	PWM624 plastic wide mouth bird guard brown	2 ZipTorq™	11528	8	111528	Display Box



111408

Indoor Lint Trap

- Clothes dryers should always be vented to the outside.
- This product should only be used temporarily.
- It must be cleaned promptly after each load.
- It cannot be used with gas dryers.
- This product is not recommended by Builder's Best as permanent dryer venting.
- This product is not recommended by clothes dryer manufacturers as dryer venting. Check your manuals as this product may invalidate warranties.
- Check local building codes for appropriate use.



Dia.	Length	Description	Clamps	Each #	Qty	Case #	Package
4"		Indoor Lint Trap bucket only		10496	48	110496	Bulk
4"		Indoor Lint Trap bucket only		10646	9	110646	Display Box
4"	5'	Indoor Lint Trap Kit, SilverDuct™ Foil	2 spring	10597	9	110597	Display Box
4"	5'	Indoor Lint Trap Kit, V220 Flex Pipe	2 steel	10497	3	110497	Ind. Box



Safety Precautions

16 Wire Helix Hose

Vinyl Duct PRO

- Thickest version of Poly Vinyl Chloride material
- Steel wire support with 1" pitch

Useful as bathroom fan venting. Not approved for dryer venting.

Dia.	Length	Clamps	Each #	Qty	Case #	Package
3"	5'		10046	12	110046	Bulk
3"	8'		11534	12	111534	Display Label
3"	8'		10047	12	110047	Bulk
3"	20'		10048	5	110048	Ind. Box
3"	50'		10053	4	110053	Ind. Box
4"	5'		10111	12	110111	Bulk
4"	8'		10052	12	110052	Display Label
4"	8'		10112	12	110112	Bulk
4"	20'		10059	5	110059	Ind. Box
4"	50'		10062	4	110062	Ind. Box
4"	8'	2 Zip Torq™	10653	12	110653	Display Bag



Vinyl Bath Vent Kits

- PRO Vinyl (see above) with Hood and two clamps

Dia.	Length	Hood	Clamps	Each #	Qty	Case #	Package
4"	8'	AWM320 aluminum wide mouth	2 ZipTorq™	11522	8	111522	Display Box
4"	8'	PML320 plastic multi louver brown	2 ZipTorq™	11510	6	111510	Display Box
4"	8'	PML320 plastic multi louver white	2 ZipTorq™	11511	6	111511	Display Box
4"	8'	PWM624 plastic wide mouth bird guard white	2 ZipTorq™	11517	8	111517	Display Box



11511
VINYL BATH KIT WITH
LOUVERED HOOD



Vinyl Duct Standard

- Lightweight version of Poly Vinyl Chloride material
- Steel wire support: 3¼" and 3" Dia. are 1" pitch; 4" Dia. is 1½" pitch
- * Useful as bathroom fan venting * Not approved for dryer venting.

Dia.	Length	Each #	Qty	Case #	Package
3"	5'	10562	12	110562	Bulk
3"	8'	10563	12	110563	Bulk
3"	8'	10563	90	010558	Bulk
3"	20'	10753	28	110753	Bulk
3"	20'	10564	5	110564	Ind. Box
3"	50'	10565	4	110565	Ind. Box
3¼"	20'	10054	28	110054	Bulk
3¼"	50'	10055	4	110055	Ind. Box
4"	5'	10566	12	110566	Bulk
4"	8'	10567	12	110567	Bulk
4"	8'	10567	72	010559	Bulk
4"	20'	10568	5	110568	Ind. Box
4"	50'	10569	4	110569	Ind. Box
4"	50'	10569	144	010743	Skid



ClearDuct™

- Thick Poly Vinyl Chloride material with steel wire support and 1" pitch
- Useful as bathroom fan venting. Not approved for dryer venting.

Dia.	Length	Clamps	Each #	Qty	Case #	Package
4"	8'	2 Zip Torq™	00017	12	100017	Display Box
4"	25'		10487	9	110487	Bulk
4"	50'		10509	4	110509	Ind. Box

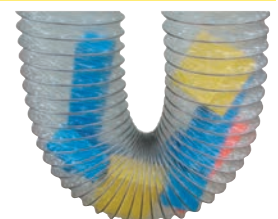

DUCT IS CLEAR
(BLOCKS NOT INCLUDED)



AEV Builder's Best Eave Vent

- Aluminum construction, fits flush into eave
- 110189 Intake does not have flapper, meeting IBC codes.
- Dryer vents should not be screened, per IBC code
- Snap-Lock™ collar connects to standard 4" or snaps without clamps to other snap-lock collars

AEV304 Intake

Dia.	Tail	Flapper	Screen	Each #	Qty	Case #	Package
4"	female	n/a	¼"x¼", ¼" round holes	10189	8	110189	Bulk

AEV320 Dryer Vent

Dia.	Tail	Flapper	Screen	Each #	Qty	Case #	Package
4"	female	flapper	n/a	10166	8	110166	Display Card
4"	female	flapper	n/a	10139	8	110139	Bulk
4"	male	flapper	n/a	10200	8	110200	Bulk

AEV324 Exhaust

Dia.	Tail	Flapper	Screen	Each #	Qty	Case #	Package
4"	female	flapper	¼"x¼", ¼" round holes	10188	8	110188	Bulk
4"	male	flapper	¼"x¼", ¼" round holes	10199	8	110199	Bulk

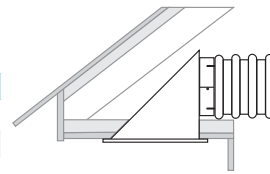

AEV304 10189

AFL349 Micro Louver Eave Vent

- Aluminum construction, fits flush into eave
- Fixed louver micro screen

Dia.	Tail/Connection	Screen	Each #	Qty	Case #	Package
3"	ring	micro	10272	20	110272	Bulk
4"	ring	micro	10273	20	110273	Bulk
3"	3 ft V230 flexible aluminum	micro	10274	16	110274	Bulk
4"	3 ft V230 flexible aluminum	micro	10275	16	110275	Bulk
3"	3" collar	micro	10556	8	110556	Bulk
4"	3" collar	micro	10555	8	110555	Bulk



110274

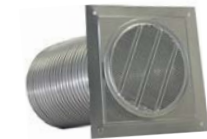

110275

Eave Vent Hoods - Plastic

RDV

- UV Stabilized polymer resin with molded in mesh bug screen
- Extra long collar for better duct connection
- Made in Canada by Primex

Dia.	Tail	Color	Screen	Qty	New Case #	Package
4"	1.7	white	bug screen	70	RDV4S01	Bulk
6"	1.4	white	bug screen	30	RDV6S01	Bulk



EVE

- Use for bathroom exhaust, handles up to 5" Dia., with backdraft damper
- Made in Canada

Dia.	Color	Each #	Qty	Case #	Package
up to 5"	White	11574	10	111574	Bulk



SV28 Exhaust

- UV stabilized polymer resin one piece design, no leaky seams, with back draft damper
- Can be used with adapter sold separately (see page 22)
- Made in Canada by Primex

Dia.	Tail	Color	Screen	New Case #	Qty	Package
4"-8"	n/a	White	removable ½" x ½"	SV2801	6	Bulk



SV2801 SHOWN ABOVE WITH ADAPTER SOLD SEPARATELY PG 22

18 Eave Vent Hoods - Plastic (continued)

SV Exhaust

- UV stabilized polymer resin one piece design, no leaky seams, with back draft damper
- Made in Canada by Primex

Dia.	Tail	Color	New Case #	Qty	Package
4"	3.3"	white	SV401	24	Bulk
6"	4.5"	white	SV601	10	Bulk



SV401

PEV620 - Exhaust

- Polypropylene molded plastic with 4 pre-drilled mounting holes
- Free swinging back draft flapper
- Can be used for bathroom fan or dryer vent

Dia.	Tail	Color	Each #	Qty	Case #	Package
3"	¾" ring	white	11830	12	111830	Bulk
3"	¾" ring	brown	11831	12	111831	Bulk
4"	¾" ring	white	11802	12	111802	Bulk
4"	¾" ring	brown	11803	12	111803	Bulk
3"	3" rigid aluminum tail	white	11806	12	111806	Bulk
3"	3" rigid aluminum tail	brown	11807	12	111807	Bulk
4"	3" rigid aluminum tail	white	11804	12	111804	Bulk
4"	3" rigid aluminum tail	brown	11805	12	111805	Bulk



11802



11807

PFL342 Mini Louver Hood with 1/2" grid

- Polypropylene molded plastic with 4 mounting holes
- 5"-8" diameters have a 1/2" 1/2" molded fixed louver grid

Dia.	Tail	Color	Each #	Qty	Case #	Package
5"	flush	white	10896	12	110896	Bulk
5"	flush	brown	11005	12	111005	Bulk
6"	flush	white	10900	12	110900	Bulk
6"	flush	brown	11503	12	111503	Bulk
7"	flush	white	10904	12	110904	Bulk
7"	flush	brown	11013	12	111013	Bulk
8"	flush	white	10908	12	110908	Bulk
8"	flush	brown	11017	12	111017	Bulk
5"	snap ring	white	10894	12	110894	Bulk
5"	snap ring	brown	11003	12	111003	Bulk
6"	snap ring	white	10898	12	110898	Bulk
6"	snap ring	brown	11007	12	111007	Bulk
7"	snap ring	white	10902	12	110902	Bulk
7"	snap ring	brown	11011	12	111011	Bulk
8"	snap ring	white	10906	12	110906	Bulk
8"	snap ring	brown	11015	12	111015	Bulk



MINI LOUVER FACE

Mini Louvers are good for eave and side wall venting. They can be used as intake or exhaust.
Not recommended for dryer venting.

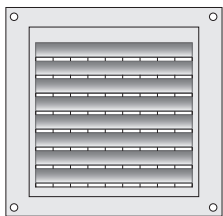

1/2" X 1/2" MOLDED
FIXED LOUVER GRID

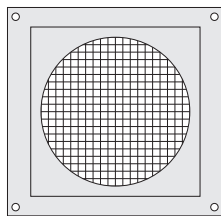

1/4" X 1/4" MOLDED GRID
ON THE INSIDE FRAME

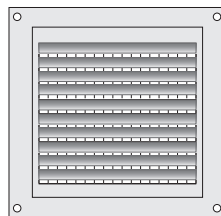

1/4" X 1/4" MOLDED
FIXED LOUVER GRID

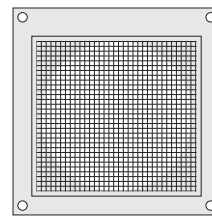

1/8" X 1/8" MOLDED
UNDER FIXED LOUVER

Grid Clarification:

- Fixed louvers create one grid
- Optional additional molded grid in frame



PFL344 Mini Louver Hood with 1/4" grid

- Polypropylene molded plastic with 4 mounting holes
- 3" & 4" diameters have a 1/4" x 1/4" molded fixed louver grid
- 5" - 8" diameters have 1/2" x 1/2" molded fixed louver grid plus a 1/4" x 1/4" molded grid on the inside frame

Dia.	Length	Color	Each #	Qty	Case #	Package	Note
3"	flush	white	10975	12	110975	Bulk	
3"	flush	brown	10976	12	110976	Bulk	
4"	flush	white	10751	12	110751	Bulk	
4"	flush	brown	10752	12	110752	Bulk	
5"	flush	white	10897	12	110897	Bulk	
5"	flush	brown	11006	12	111006	Bulk	
6"	flush	white	10901	12	110901	Bulk	
6"	flush	brown	11010	12	111010	Bulk	
7"	flush	white	10905	12	110905	Bulk	
7"	flush	brown	11014	12	111014	Bulk	
8"	flush	white	10909	12	110909	Bulk	
8"	flush	brown	11018	12	111018	Bulk	
3"	snap ring	white	10694	12	110694	Bulk	
3"	snap ring	brown	10682	12	110682	Bulk	
4"	snap ring	white	10811	12	110811	Bulk	
4"	snap ring	brown	10972	12	110972	Bulk	
5"	snap ring	white	10895	12	110895	Bulk	
5"	snap ring	brown	11004	12	111004	Bulk	
6"	snap ring	white	10899	12	110899	Bulk	
6"	snap ring	brown	11008	12	111008	Bulk	
7"	snap ring	white	10903	12	110903	Bulk	
7"	snap ring	brown	11012	12	111012	Bulk	
8"	snap ring	white	10907	12	110907	Bulk	
8"	snap ring	brown	11016	12	111016	Bulk	
3"	3" male collar	white	11599	12	111599	Bulk	UPC LBL
4"	3" male collar	white	11609	12	111609	Bulk	UPC LBL
3"	3" male collar	white	10695	12	110695	Bulk	
3"	3" male collar	brown	10681	12	110681	Bulk	
4"	3" male collar	white	10812	12	110812	Bulk	
4"	3" male collar	brown	10519	12	110519	Bulk	
6"	4" female tail	white	11918	4	111918	Bulk	
6"	4" female tail	brown	11919	4	111919	Bulk	
3"	10" female tail	white	10893	12	110893	Bulk	
3"	10" female tail	brown	10683	12	110683	Bulk	
4"	10" female tail	white	10813	12	110813	Bulk	
4"	10" female tail	brown	10971	12	110971	Bulk	
3"	3' flexible aluminum	white	11251	16	111251	Bulk	
3"	3' flexible aluminum	brown	10977	16	110977	Bulk	
4"	3' flexible aluminum	white	11249	16	111249	Bulk	
4"	3' flexible aluminum	brown	10973	16	110973	Bulk	

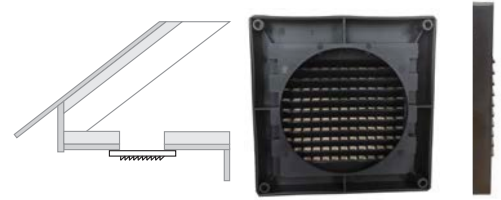

10752
FLUSH

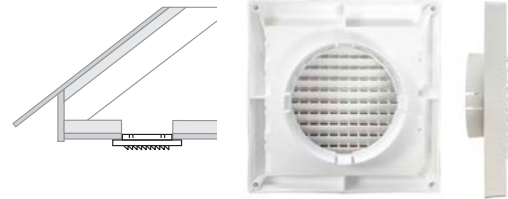

10694
SNAP ON RING

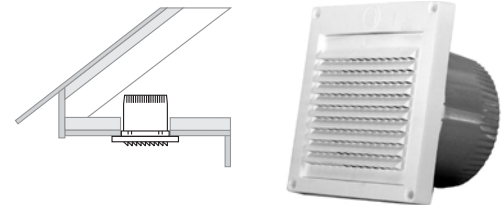

110812 WITH 3" RIGID
ALUMINUM TAIL

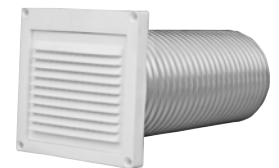

111249 WITH 3' FLEXIBLE
ALUMINUM TAIL

PFL348 Mini Louver Hood with 1/8" screen

- Polypropylene molded plastic with 4 mounting holes
- Fixed louvers with a 1/4" x 1/4" molded fixed louver grid plus a 1/8" x 1/8" wire mesh screen under the fixed louver

Dia.	Tail	Color	Each #	Qty	Case #	Package
4"	flush	white	12344	12	112344	Bulk
4"	flush	brown	12345	12	112345	Bulk
4"	snap ring	white	10754	12	110754	Bulk
4"	snap ring	brown	10974	12	110974	Bulk



10974
RING & MESH SCREEN

20 Roof Vent Hoods - Aluminum

ARV Aluminum Roof Vent Heavy Gauge

- 24 gauge mill finish aluminum
- Available with 4" collar and flush



011754

ARV620 with flapper

Dia.	Tail	Flapper	Screen	Each #	Qty	Case #	Package
4"	flush	flapper	n/a	11751	1	011751	Ind. Box
4"	with collar	flapper	n/a	11746	1	011746	Ind. Box

ARV624 with flapper & screen

Dia.	Tail	Flapper	Screen	Each #	Qty	Case #	Package
4"	flush	flapper	¼"x¼" removable	11748	1	011748	Ind. Box
4"	with collar	flapper	¼"x¼" removable	11749	1	011749	Ind. Box
6"	flush	flapper	¼"x¼" removable	11795	1	011795	Ind. Box
6"	with collar	flapper	¼"x¼" removable	11796	1	011796	Ind. Box
6"-8" (3¼"x10")	flush	flapper	¼"x¼" removable	11754	1	011754	Ind. Box
7"	flush	flapper	¼"x¼" removable	11747	1	011747	Ind. Box
7"	with collar	flapper	¼"x¼" removable	11753	1	011753	Ind. Box

Roof Vent Hoods - Galvanized

Umbrella Cap™

- Galvanized steel, rigid ribbed construction
- Economical protection from rain and snow for flues and vent pipes



010959

Tail Dia.	Cap Dia.	Each #	Qty	Case #	Package
3"	8"	10957	1	010957	Ind. Box
4"	8"	10958	1	010958	Ind. Box
5"	12"	10959	1	010959	Ind. Box
6"	12"	10960	1	010960	Ind. Box
7"	12"	10961	1	010961	Ind. Box
8"	12"	10962	1	010962	Ind. Box
9"	17"	10963	1	010963	Ind. Box
10"	17"	10964	1	010964	Ind. Box
12"	17"	10965	1	010965	Ind. Box

Creative Crown Roof Vent Cap

- 26 gauge galvanized steel construction for corrosion resistance with riveted assembly
- Designed to fit over a Type B gas vent (see spec sheet for complete dimensions)
- Efficiently evacuates fumes from flues or pipes and helps eliminate down-drafts
- May also be used as a storm-proof air intake or exhaust



010922

Tail Dia.	Cap Dia.	Each #	Qty	Case #	Package
3"	8	10921	1	010921	Ind. Box
4"	9	10922	1	010922	Ind. Box
5"	10.625	10923	1	010923	Ind. Box
6"	11	10924	1	010924	Ind. Box
7"	13.750	10925	1	010925	Ind. Box
8"	15.125	10926	1	010926	Ind. Box
9"	17.5	10927	1	010927	Ind. Box
10"	19	10928	1	010928	Ind. Box
12"	22	10929	1	010929	Ind. Box



Broad Band Siphon Ventilator™

- 26 gauge galvanized steel construction with large unrestricted outlet
- Storm proof – helps prevent downdrafts
- Ribbed cap and wide band provide maximum protection and create strong siphoning action



010941

Tail Dia.	Overall Dia.	Height	Each #	Qty	Case #	Package
3"	11"	6"	10939	1	010939	Ind. Box
4"	11"	6"	10940	1	010940	Ind. Box
5"	15"	7.5"	10941	1	010941	Ind. Box
6"	15"	7.5"	10942	1	010942	Ind. Box
7"	15"	7.5"	10943	1	010943	Ind. Box
8"	15"	7.5"	10944	1	010944	Ind. Box
9"	20"	10"	10945	1	010945	Ind. Box
10"	20"	10"	10946	1	010946	Ind. Box
12"	20"	10"	10947	1	010947	Ind. Box

GRV Spangled Galvanized Roof Vent Heavy Gauge

- 26 gauge galvanized mill finish steel

GRV620 with flapper

Dia.	Tail	Flapper	Screen	Each #	Qty	Case #	Package
4"	flush	flapper	n/a	12120	1	012120	Ind. Box
4"	with collar	flapper	n/a	12121	1	012121	Ind. Box



011756

GRV624 with flapper & screen

Dia.	Tail	Flapper	Screen	Each #	Qty	Case #	Package
4"	flush	flapper	¼"x¼" removable	11755	1	011755	Ind. Box
4"	with collar	flapper	¼"x¼" removable	11756	1	011756	Ind. Box
6"	flush	flapper	¼"x¼" removable	11793	1	011793	Ind. Box
6"	with collar	flapper	¼"x¼" removable	11794	1	011794	Ind. Box
6"-8" (3¼"x10")	flush	flapper	¼"x¼" removable	11772	1	011772	Ind. Box
7"	flush	flapper	¼"x¼" removable	11773	1	011773	Ind. Box
7"	with collar	flapper	¼"x¼" removable	11868	1	011868	Ind. Box
10"	flush	flapper	¼"x¼" removable	11774	1	011774	Ind. Box



011772

Roof Vent Hoods - Galvanized Black Powder Coat

GRV Black Galvanized Roof Vent Heavy Gauge

- 26 gauge galvanized steel with black powder coat finish

GRV820 with flapper

Dia.	Tail	Flapper	Screen	Each #	Qty	Case #	Package
4"	flush	flapper	n/a	12642	1	012642	Ind. Box
4"	with collar	flapper	n/a	12643	1	012643	Ind. Box



012635

GRV824 with flapper & screen

Dia.	Tail	Flapper	Screen	Each #	Qty	Case #	Package
4"	with collar	flapper	¼"x¼" removable	12635	1	012635	Ind. Box
4"	with collar	flapper	¼"x¼" removable	12645	1	012645	Display Box
4"	flush	flapper	¼"x¼" removable	12636	1	012636	Ind. Box
4"	flush	flapper	¼"x¼" removable	12646	1	012646	Display Box
6"	flush	flapper	¼"x¼" removable	12632	1	012632	Ind. Box
6"	with collar	flapper	¼"x¼" removable	12633	1	012633	Ind. Box
7"	with collar	flapper	¼"x¼" removable	12639	1	012639	Ind. Box
6"-8" (3¼"x10")	flush	flapper	¼"x¼" removable	12634	1	012634	Ind. Box
10"	flush	flapper	¼"x¼" removable	12638	1	012638	Ind. Box



012636

Kit 012640 includes: Roof Cap, 4" x 8" UL® 181 Foil Duct, one 3-4" plastic increaser reducer, two ZipTorq clamps

4"	with collar	flapper	¼"x¼" removable	12640	1	012640	Display Box
----	-------------	---------	-----------------	-------	---	--------	-------------



22 Roof Vent Hoods - Plastic

RV28 Gooseneck Roof Cap

- UV protected polymer resin, one piece, seamless construction
- 26.5 square inches mouth opening
- 4" thru 8" snap-in adapters available separately
- Made in Canada by Primex



Dia.	Color	Mouth	Damper	Screen	New PN	Qty	Package
4"-8"	black	wide	removable	removable ½" x ½"	RV2825	5	Bulk

Adapters (for RV28, RVL28, & SV28 Eave)

- Snap fits with RV28 Gooseneck Roof Cap, RVL28 Low Profile Roof Cap & SV28 Eave Vent
- Made in Canada by Primex

Dia.	Color	New PN	Qty	Package
4"	black	RV28-4	30	Bulk
5"	black	RV28-5	30	Bulk
6"	black	RV28-6	25	Bulk
7"	black	RV28-7	25	Bulk
8"	black	RV28-8	18	Bulk



RVL28 Low Profile Roof Cap

- UV protected polymer resin, one piece, seamless construction
- 27.8 square inch mouth opening
- 4" thru 8" snap-in adapters available separately
- Made in Canada by Primex



Dia.	Color	Mouth	Damper	Screen	New PN	Qty	Package
4"-8"	black	wide	removable	removable ½" x ½"	RVL2825	6	Bulk

Duraflo® Roof Cap

- Heavy duty black plastic (polypropylene), modified for impact and UV resistance
- Exhausts dryer vents or bathroom fan vents thru the roof.
- Flexible flange
- Unique chatterless flapper
- Available flush mount or with a 3" long collar which adapts to 4" & 5" pipe
- Made in Canada by Duraflo/Canplas



111507 DRYER VENT

Dia.	Use for:	Opening	Flapper	Screen	Each #	Qty	Case #	Package
4"-5"	dryer vent	collar	chatterless	molded	11250	6	111250	Bulk
up to 5"	dryer vent	flush	chatterless	molded	11507	4	111507	Bulk
4" - 5"	bathroom vent	collar	chatterless	molded	11508	6	111508	Bulk
up to 5"	bathroom vent	flush	chatterless	molded	11509	4	111509	Bulk

Vent Kit 011885 includes: 4" x 8' UL 181 foil, increaser/reducer and clamps

4" - 5"	bathroom vent	collar	chatterless	molded	11885	1	011885	Ind. Box
---------	---------------	--------	-------------	--------	-------	---	--------	----------



111508 BATH VENT WITH COLLAR

Wall Vent Hoods - Aluminum Rectangular

ARR Aluminum Rectangular Hood

- 24 gauge aluminum
- Fully assembled riveted construction, no caulk
- Foam flapper seals for quiet closure

ARR630

Dia.	Tail	Mouth	Flapper	Screen	Each #	Qty	Case #	Package
3.25 x 10"	5"	rectangular	spring flapper	n/a	11929	14	111929	Bulk
3.25 x 10"	11"	rectangular	spring flapper	n/a	11377	8	111377	Bulk

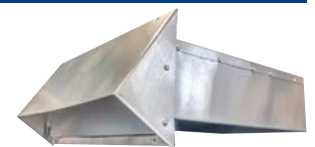

111377 NO SCREEN

ARR634

Dia.	Tail	Mouth	Flapper	Screen	Each #	Qty	Case #	Package
3.25 x 10"	11"	rectangular	flapper	¼"x¼"	12322	8	112322	Bulk



112322 SCREEN & FLAPPER



AWM Alumium Wide Mouth Hood

- 30 gauge aluminum
- Fully assembled riveted construction, no caulk

AWM320 with flapper

Dia.	Tail	Mouth	Flapper	Screen	Each #	Qty	Case #	Package
4"	flush	wide	flapper	n/a	10557	24	110557	Bulk
4"	4 in	wide	flapper	n/a	10791	18	110791	Bulk
3"	11.5"	wide	flapper	n/a	10270	12	110270	Bulk
3"	11.5"	wide	flapper	n/a	10328	4	110328	Ind. Box
4"	11.5"	wide	flapper	n/a	10170	6	110170	Display Tray
4"	11.5"	wide	flapper	n/a	10271	12	110271	Bulk
4"	11.5"	wide	flapper	n/a	10326	4	110326	Ind. Box



110271



110270

AWM324 with flapper & screen

Dia.	Tail	Mouth	Flapper	Screen	Each #	Qty	Case #	Package
4"	flush	wide	flapper	¼"x¼"	10786	24	110786	Bulk
4"	11.5"	wide	flapper	¼"x¼"	10684	12	110684	Bulk

ASM Alumium Standard Mouth Hood

- 30 gauge aluminum
- Fully assembled riveted construction, no caulk

ASM320 with flapper

Dia.	Tail	Mouth	Flapper	Screen	Each #	Qty	Case #	Package
3"	11.5"	standard	flapper	n/a	10276	12	110276	Bulk
3"	11.5"	standard	flapper	n/a	10278	4	110278	Ind. Box
4"	11.5"	standard	flapper	n/a	10277	12	110277	Bulk
4"	11.5"	standard	flapper	n/a	10279	4	110279	Ind. Box

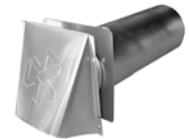

ASM320

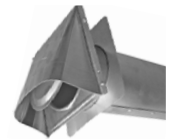

ASM320 FLAPPER

Aluminum Trim Plate

* For aluminum hoods AWM3xx, ASM3xx, plastic hoods PWM6xx

Dia.	Material	Note	Each #	Qty	Case #	Package
3"	Aluminum		10126	100	110126	Bulk
4"	Aluminum		10122	100	110122	Bulk
4"	Aluminum	mounting holes	10912	100	110912	Bulk
3"	P-Tanium™ Galvanized		10056	100	110056	Bulk
4"	P-Tanium™ Galvanized		10057	100	110057	Bulk



Window Plate

- 12" high by 18" wide Aluminum

Dia.	Each #	Qty	Case #	Package
3"	10494	25	110494	Bulk
4"	10495	25	110495	Bulk



24 Wall Vent Hoods - Heavy Aluminum

AWM Aluminum Wide Mouth Heavy Gauge Hoods

- 26 gauge Aluminum
- Riveted construction, no caulk
- Mouth opening exceeds pipe area
- 4 mounting holes for secure connections

AWM604 with screen

Dia.	Tail	Flapper	Screen	Each #	Qty	Case #	Pkg
4"	flush	n/a	¼"x¼" removable	11173	20	111173	Bulk
4"	6"	n/a	¼"x¼" removable	11115	12	111115	Bulk
4"	11"	n/a	¼"x¼" removable	11105	12	011106	Bulk
5"	flush	n/a	¼"x¼" removable	11175	12	111175	Bulk
5"	6"	n/a	¼"x¼" removable	11117	12	111117	Bulk
5"	11"	n/a	¼"x¼" removable	11107	6	111107	Bulk
6"	flush	n/a	¼"x¼" removable	11177	12	111177	Bulk
6"	6"	n/a	¼"x¼" removable	11119	12	111119	Bulk
6"	11"	n/a	¼"x¼" removable	11109	6	111109	Bulk
7"	flush	n/a	¼"x¼" removable	11179	12	111179	Bulk
7"	6"	n/a	¼"x¼" removable	11121	10	111121	Bulk
7"	11"	n/a	¼"x¼" removable	11111	6	111111	Bulk
8"	flush	n/a	¼"x¼" removable	11181	12	111181	Bulk
8"	6"	n/a	¼"x¼" removable	11122	10	111122	Bulk
8"	11"	n/a	¼"x¼" removable	11112	6	111112	Bulk
10"	flush	n/a	¼"x¼" removable	11183	2	111183	Bulk
10"	6"	n/a	¼"x¼" removable	11123	2	111123	Bulk
10"	11"	n/a	¼"x¼" removable	11113	1	011113	Ind Box
12"	flush	n/a	¼"x¼" removable	11185	2	111185	Bulk
12"	6"	n/a	¼"x¼" removable	11124	2	111124	Bulk
12"	11"	n/a	¼"x¼" removable	11114	1	011114	Ind Box



111123
SCREEN

AWM620 with flapper

Dia.	Tail	Flapper	Screen	Each #	Qty	Case #	Pkg
4"	flush	flapper	n/a	11159	20	111159	Bulk
4"	6"	flapper	n/a	11145	12	111145	Bulk
4"	11"	flapper	n/a	11147	12	011148	Bulk
5"	flush	flapper	n/a	11161	12	111161	Bulk
5"	6"	flapper	n/a	11066	12	111066	Bulk
5"	11"	flapper	n/a	11097	6	111097	Bulk
6"	flush	flapper	n/a	11163	12	111163	Bulk
6"	6"	flapper	n/a	11068	12	111068	Bulk
6"	11"	flapper	n/a	11099	6	111099	Bulk
7"	flush	flapper	n/a	11165	12	111165	Bulk
7"	6"	flapper	n/a	11070	10	111070	Bulk
7"	11"	flapper	n/a	11101	6	111101	Bulk
8"	flush	flapper	n/a	11167	12	111167	Bulk
8"	6"	flapper	n/a	11071	10	111071	Bulk
8"	11"	flapper	n/a	11102	6	111102	Bulk
10"	flush	flapper	n/a	11169	2	111169	Bulk
10"	6"	flapper	n/a	11072	2	111072	Bulk
10"	11"	flapper	n/a	11103	1	011103	Ind Box
12"	flush	flapper	n/a	11171	2	111171	Bulk
12"	6"	flapper	n/a	11073	2	111073	Bulk
12"	11"	flapper	n/a	11104	1	011104	Ind Box



111167
FLAPPER NO SCREEN



FLAPPER NO SCREEN



AWM Aluminum Wide Mouth Heavy Gauge Hoods (continued)

AWM624 with flapper & screen

Dia.	Tail	Flapper	Screen	Each #	Qty	Case #	Pkg
4"	flush	flapper	¼"x¼" removable	11187	20	111187	Bulk
4"	6"	flapper	¼"x¼" removable	11056	12	111056	Bulk
4"	11"	flapper	¼"x¼" removable	11045	12	011046	Bulk
5"	flush	flapper	¼"x¼" removable	11189	12	111189	Bulk
5"	6"	flapper	¼"x¼" removable	11058	12	111058	Bulk
5"	11"	flapper	¼"x¼" removable	11047	6	111047	Bulk
6"	flush	flapper	¼"x¼" removable	11191	12	111191	Bulk
6"	6"	flapper	¼"x¼" removable	11060	12	111060	Bulk
6"	11"	flapper	¼"x¼" removable	11049	6	111049	Bulk
7"	flush	flapper	¼"x¼" removable	11193	12	111193	Bulk
7"	6"	flapper	¼"x¼" removable	11062	10	111062	Bulk
7"	11"	flapper	¼"x¼" removable	11050	6	111050	Bulk
8"	flush	flapper	¼"x¼" removable	11195	12	111195	Bulk
8"	6"	flapper	¼"x¼" removable	11063	10	111063	Bulk
8"	11"	flapper	¼"x¼" removable	11051	6	111051	Bulk
10"	flush	flapper	¼"x¼" removable	11197	2	111197	Bulk
10"	6"	flapper	¼"x¼" removable	11064	2	111064	Bulk
10"	11"	flapper	¼"x¼" removable	11052	1	011052	Ind Box
12"	n/a	flapper	¼"x¼" removable	11199	2	111199	Bulk
12"	6"	flapper	¼"x¼" removable	11065	2	111065	Bulk
12"	11"	flapper	¼"x¼" removable	11053	1	011053	Ind Box



011046
FLAPPER & SCREEN



111064
FLAPPER & SCREEN



111811
SPRING FLAPPER



FLAPPER NO SCREEN

AWM630 with spring flapper

Dia.	Tail	Flapper	Screen	Each #	Qty	Case #	Pkg
4"	flush	spring flapper	n/a	11813	20	111813	Bulk
4"	6"	spring flapper	n/a	11820	12	111820	Bulk
5"	6"	spring flapper	n/a	11821	12	111821	Bulk
6"	flush	spring flapper	n/a	11811	12	111811	Bulk
6"	2¾"	spring flapper	n/a	11906	8	111906	Bulk
6"	6"	spring flapper	n/a	11387	12	111387	Bulk
6"	6"	spring flapper	n/a	11641	1	011641	Ind Box
7"	6"	spring flapper	n/a	11822	10	111822	Bulk
8"	6"	spring flapper	n/a	11823	10	111823	Bulk
8"	6"	spring flapper	n/a	12085	1	012085	Ind Box
10"	6"	spring flapper	n/a	11824	2	111824	Bulk
12"	6"	spring flapper	n/a	11825	2	111825	Bulk

AWM634 with spring flapper & screen

Dia.	Tail	Flapper	Screen	Each #	Qty	Case #	Pkg
6"	flush	spring flapper	¼"x¼" removable	11403	12	111403	Bulk
6"	6"	spring flapper	¼"x¼" removable	11840	12	111840	Bulk

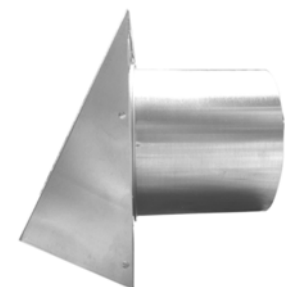

GWM P-Tanium™ Galvanized Wide Mouth Heavy Gauge Hoods

- 26 gauge P-Tanium™ paintable galvanized steel with plain face
- Mouth opening exceeds pipe area for best airflow
- Riveted construction, no caulk
- 4 mounting holes for secure connections

GWM704 with screen

Dia.	Tail Length	Flapper	Screen	Each #	Qty	Case #	Pkg
4"	flush	n/a	¼"x¼" removable	12042	20	112042	Bulk
4"	6"	n/a	¼"x¼" removable	12067	12	112067	Bulk
4"	11"	n/a	¼"x¼" removable	12068	12	112068	Bulk
5"	flush	n/a	¼"x¼" removable	12216	12	112216	Bulk
5"	6"	n/a	¼"x¼" removable	12212	12	112212	Bulk
5"	11"	n/a	¼"x¼" removable	12213	6	112213	Bulk
6"	flush	n/a	¼"x¼" removable	12044	12	112044	Bulk
6"	6"	n/a	¼"x¼" removable	12240	12	112240	Bulk
6"	11"	n/a	¼"x¼" removable	12215	6	112215	Bulk
7"	flush	n/a	¼"x¼" removable	12415	12	112415	Bulk
7"	6"	n/a	¼"x¼" removable	12314	10	112314	Bulk
7"	11"	n/a	¼"x¼" removable	11839	6	111839	Bulk
8"	flush	n/a	¼"x¼" removable	12115	12	112115	Bulk
8"	6"	n/a	¼"x¼" removable	12243	10	112243	Bulk
8"	11"	n/a	¼"x¼" removable	12245	6	112245	Bulk



SIDE VIEW



12240



12043



GWM720
FLAPPER NO SCREEN

GWM720 with flapper

Dia.	Tail Length	Flapper	Screen	Each #	Qty	Case #	Pkg
4"	flush	flapper	n/a	12041	20	112041	Bulk
4"	6"	flapper	n/a	12219	12	112219	Bulk
4"	11"	flapper	n/a	11708	12	111708	Bulk
5"	flush	flapper	n/a	11420	12	111420	Bulk
5"	6"	flapper	n/a	12069	12	112069	Bulk
5"	11"	flapper	n/a	11939	6	111939	Bulk
6"	flush	flapper	n/a	12043	12	112043	Bulk
6"	6"	flapper	n/a	12066	12	112066	Bulk
6"	11"	flapper	n/a	11711	6	111711	Bulk
7"	flush	flapper	n/a	12318	12	112318	Bulk
7"	6"	flapper	n/a	12378	10	112378	Bulk
7"	11"	flapper	n/a	11798	6	111798	Bulk
8"	flush	flapper	n/a	12418	12	112418	Bulk
8"	6"	flapper	n/a	12070	10	112070	Bulk
8"	11"	flapper	n/a	11841	6	111841	Bulk

GWM724 with flapper & screen

Dia.	Tail Length	Flapper	Screen	Each #	Qty	Case #	Pkg
4"	flush	flapper	¼"x¼" removable	12420	20	112420	Bulk
4"	6"	flapper	¼"x¼" removable	12210	12	112210	Bulk
4"	11"	flapper	¼"x¼" removable	12211	12	112211	Bulk
5"	flush	flapper	¼"x¼" removable	12317	12	112317	Bulk
5"	6"	flapper	¼"x¼" removable	12071	12	112071	Bulk
5"	11"	flapper	¼"x¼" removable	12419	6	112419	Bulk
6"	flush	flapper	¼"x¼" removable	12217	12	112217	Bulk
6"	6"	flapper	¼"x¼" removable	12214	12	112214	Bulk
6"	11"	flapper	¼"x¼" removable	11838	6	111838	Bulk
7"	flush	flapper	¼"x¼" removable	12319	12	112319	Bulk
7"	6"	flapper	¼"x¼" removable	12241	10	112241	Bulk
7"	11"	flapper	¼"x¼" removable	12379	6	112379	Bulk
8"	flush	flapper	¼"x¼" removable	12084	12	112084	Bulk
8"	6"	flapper	¼"x¼" removable	12242	10	112242	Bulk
8"	11"	flapper	¼"x¼" removable	12323	6	112323	Bulk



12217



FLAPPER & SCREEN

GWM P-Tanium™ Galvanized Wide Mouth Heavy Gauge Hoods (continued)

GWM730 with spring flapper

Dia.	Tail Length	Flapper	Screen	Each #	Qty	Case #	Pkg
4"	6"	spring flapper	n/a	11843	12	111843	Bulk



FLAPPER NO SCREEN

GWM734 with spring flapper & screen

Dia.	Tail Length	Flapper	Screen	Each #	Qty	Case #	Pkg
4"	6"	spring flapper	¼"x¼" removable	11842	12	111842	Bulk
6"	6"	spring flapper	¼"x¼" removable	11844	12	111844	Bulk



FLAPPER & SCREEN

Wall Vent Hoods - Galvanized

Galvanized P-Tanium™ Hoods

- 30 gauge paintable galvanized
- Riveted construction, no caulk



GWM404 Wide Mouth with screen

Dia.	Tail Length	Mouth	Flapper	Screen	Each #	Qty	Case #	Package
4"	flush	wide	no	¼"x¼"	12410	24	112410	Bulk

GWM420 Wide Mouth with flapper

Dia.	Tail Length	Mouth	Flapper	Screen	Each #	Qty	Case #	Package
3"	11.5"	wide	flapper	n/a	10887	12	110887	Bulk
4"	flush	wide	flapper	n/a	11157	24	111157	Bulk
4"	11.5"	wide	flapper	n/a	10648	6	110648	Display Tray
4"	11.5"	wide	flapper	n/a	11430	8	111430	Display Card
4"	11.5"	wide	flapper	n/a	10889	12	110889	Bulk



10891
WIDE MOUTH

GWM424 Wide Mouth with flapper & screen

Dia.	Tail Length	Mouth	Flapper	Screen	Each #	Qty	Case #	Package
4"	flush	wide	flapper	¼"x¼"	12341	24	112341	Bulk
4"	11.5"	wide	flapper	¼"x¼"	10891	12	110891	Bulk

GSM404 Standard Mouth with screen

Dia.	Tail Length	Mouth	Flapper	Screen	Each #	Qty	Case #	Package
4"	11.5"	standard	no	¼"x¼"	10729	12	110729	Bulk

GSM420 Standard Mouth with flapper

Dia.	Tail Length	Mouth	Flapper	Screen	Each #	Qty	Case #	Package
3"	11.5"	standard	flapper	n/a	10883	12	110883	Bulk
4"	flush	standard	flapper	n/a	11419	24	111419	Bulk
4"	11.5"	standard	flapper	n/a	10885	12	110885	Bulk
4"	11.5"	standard	flapper	n/a	10750	4	110750	Ind. Box



10729
STANDARD MOUTH

P-Tanium™

- Paintable galvanized
- Mill finish color may vary slightly

P-Tanium™ Trim Plates

Dia.	Each #	Qty	Case #	Package
3"	10056	100	110056	Bulk
4"	10057	100	110057	Bulk

28 Wall Vent Hoods - Heavy Galvanized

GWM Spangled Galvanized Wide Mouth Heavy Gauge Hoods

- 26 gauge galvanized steel
- Riveted construction, no caulk
- Mouth opening exceeds pipe area
- 4 mounting holes for secure connections

GWM602 with screen

Dia.	Tail	Flapper	Screen	Each #	Qty	Case #	Pkg
4"	6"	n/a	½"x½" removable	11427	12	111427	Bulk



11427
½" X ½" SCREEN

GWM604 with screen

Dia.	Tail	Flapper	Screen	Each #	Qty	Case #	Pkg
4"	flush	n/a	¼"x¼" removable	11215	20	111215	Bulk
4"	6"	n/a	¼"x¼" removable	11076	12	111076	Bulk
4"	11"	n/a	¼"x¼" removable	11087	12	011088	Bulk
5"	flush	n/a	¼"x¼" removable	11217	12	111217	Bulk
5"	6"	n/a	¼"x¼" removable	11078	12	111078	Bulk
5"	11"	n/a	¼"x¼" removable	11089	6	111089	Bulk
6"	flush	n/a	¼"x¼" removable	11219	12	111219	Bulk
6"	6"	n/a	¼"x¼" removable	11080	12	111080	Bulk
6"	11"	n/a	¼"x¼" removable	11091	6	111091	Bulk
7"	flush	n/a	¼"x¼" removable	11221	12	111221	Bulk
7"	6"	n/a	¼"x¼" removable	11081	10	111081	Bulk
7"	11"	n/a	¼"x¼" removable	11093	6	111093	Bulk
8"	flush	n/a	¼"x¼" removable	11223	12	111223	Bulk
8"	6"	n/a	¼"x¼" removable	11082	10	111082	Bulk
8"	11"	n/a	¼"x¼" removable	11094	6	111094	Bulk
10"	flush	n/a	¼"x¼" removable	11225	2	111225	Bulk
10"	6"	n/a	¼"x¼" removable	11083	2	111083	Bulk
10"	11"	n/a	¼"x¼" removable	11095	1	011095	Ind Box
12"	flush	n/a	¼"x¼" removable	11227	2	111227	Bulk
12"	6"	n/a	¼"x¼" removable	11084	2	111084	Bulk
12"	11"	n/a	¼"x¼" removable	11096	1	011096	Ind Box

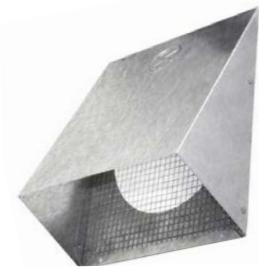

11219
¼" X ¼" SCREEN

GWM620 with flapper

Dia.	Tail	Flapper	Screen	Each #	Qty	Case #	Pkg
4"	flush	flapper	n/a	11201	20	111201	Bulk
4"	6"	flapper	n/a	11125	12	111125	Bulk
4"	11"	flapper	n/a	11135	12	011136	Bulk
5"	flush	flapper	n/a	11203	12	111203	Bulk
5"	6"	flapper	n/a	11127	12	111127	Bulk
5"	11"	flapper	n/a	11137	6	111137	Bulk
6"	flush	flapper	n/a	11205	12	111205	Bulk
6"	6"	flapper	n/a	11129	12	111129	Bulk
6"	11"	flapper	n/a	11139	6	111139	Bulk
7"	flush	flapper	n/a	11207	12	111207	Bulk
7"	6"	flapper	n/a	11131	10	111131	Bulk
7"	11"	flapper	n/a	11141	6	111141	Bulk
8"	flush	flapper	n/a	11209	12	111209	Bulk
8"	6"	flapper	n/a	11132	10	111132	Bulk
8"	11"	flapper	n/a	11142	6	111142	Bulk
10"	flush	flapper	n/a	11211	2	111211	Bulk
10"	6"	flapper	n/a	11133	2	111133	Bulk
10"	11"	flapper	n/a	11143	1	011143	Ind Box
12"	flush	flapper	n/a	11213	2	111213	Bulk
12"	6"	flapper	n/a	11134	2	111134	Bulk
12"	11"	flapper	n/a	11144	1	011144	Ind Box



11125



11139



GWM Spangled Galvanized Wide Mouth Heavy Gauge Hoods (continued)

GWM624 with flapper & screen

Dia.	Tail	Flapper	Screen	Each #	Qty	Case #	Pkg
4"	flush	flapper	¼"x¼" removable	11229	20	111229	Bulk
4"	6"	flapper	¼"x¼" removable	11033	12	111033	Bulk
4"	11"	flapper	¼"x¼" removable	11022	12	011023	Bulk
5"	flush	flapper	¼"x¼" removable	11231	12	111231	Bulk
5"	6"	flapper	¼"x¼" removable	11035	12	111035	Bulk
5"	11"	flapper	¼"x¼" removable	11024	6	111024	Bulk
6"	flush	flapper	¼"x¼" removable	11233	12	111233	Bulk
6"	6"	flapper	¼"x¼" removable	11037	12	111037	Bulk
6"	11"	flapper	¼"x¼" removable	11026	6	111026	Bulk
7"	flush	flapper	¼"x¼" removable	11235	12	111235	Bulk
7"	6"	flapper	¼"x¼" removable	11038	10	111038	Bulk
7"	11"	flapper	¼"x¼" removable	11027	6	111027	Bulk
8"	flush	flapper	¼"x¼" removable	11237	12	111237	Bulk
8"	6"	flapper	¼"x¼" removable	11039	10	111039	Bulk
8"	11"	flapper	¼"x¼" removable	11028	6	111028	Bulk
10"	flush	flapper	¼"x¼" removable	11239	2	111239	Bulk
10"	6"	flapper	¼"x¼" removable	11040	2	111040	Bulk
10"	11"	flapper	¼"x¼" removable	11029	1	011029	Ind Box
12"	flush	flapper	¼"x¼" removable	11241	2	111241	Bulk
12"	6"	flapper	¼"x¼" removable	11041	2	111041	Bulk
12"	11"	flapper	¼"x¼" removable	11030	1	011030	Ind Box



11026



11027

FLAPPER & SCREEN



11028

FLAPPER & SCREEN

GWM630 with spring flapper

Dia.	Tail	Flapper	Screen	Each #	Qty	Case #	Pkg
4"	11"	spring flapper	n/a	11643	15	111643	Bulk
6"	11"	spring flapper	n/a	11644	6	111644	Bulk

Wall Vent Hoods - Galvanized

Spangled Galvanized Hood

- 30 gauge spangled galvanized
- Riveted construction, no caulk

GWM320 Wide Mouth with flapper

Dia.	Tail Length	Mouth	Flapper	Screen	Each #	Qty	Case #	Package
3"	11.5	wide	flapper	n/a	10770	12	110770	Bulk
4"	flush	wide	flapper	n/a	10699	24	110699	Bulk
4"	11.5	wide	flapper	n/a	10771	12	110771	Bulk



10771

WIDE MOUTH

GSM320 Standard Mouth with flapper

Dia.	Tail Length	Mouth	Flapper	Screen	Each #	Qty	Case #	Package
4"	11.5	standard	flapper	n/a	10732	12	110732	Bulk



30 Wall Vent Hoods - Plastic

SM Side Wall Cap

- UV-stabilized durable polymer resin
- One-piece seamless design helps eliminate leaky joints while maximizing water protection
- Made in Canada by Primex

Dia.	Color	Flapper	Screen	New PN	Qty	Package
4"	white	spring	removable ½" x ½"	SM401	24	Bulk
4"	light grey	spring	removable ½" x ½"	SM431	24	Bulk
6"	white	spring	removable ½" x ½"	SM601	10	Bulk



WC Wall Cap

- UV-stabilized durable polymer resin
- Drip edge to drain away water
- Screen is not removable
- Made in Canada by Primex

Dia.	Color	Mouth	Flapper	Screen	New PN	Qty	Package
4"	white	wide	removable spring	½" x ½"	WC401S	25	Bulk
4"	white	wide	removable spring	n/a	WC401SNS	25	Bulk
4"	taupe	wide	removable spring	½" x ½"	WC423S	25	Bulk
4"	taupe	wide	removable spring	n/a	WC423SNS	25	Bulk
4"	black	wide	removable spring	½" x ½"	WC425S	25	Bulk
4"	black	wide	removable spring	n/a	WC425SNS	25	Bulk
4"	dark grey	wide	removable spring	½" x ½"	WC428S	25	Bulk
4"	dark grey	wide	removable spring	n/a	WC428SNS	25	Bulk
4"	light grey	wide	removable spring	½" x ½"	WC431S	25	Bulk
4"	light grey	wide	removable spring	n/a	WC431SNS	25	Bulk
4"	tan	wide	removable spring	½" x ½"	WC445S	25	Bulk
4"	tan	wide	removable spring	n/a	WC445SNS	25	Bulk
4"	dark brown	wide	removable spring	½" x ½"	WC468S	25	Bulk
4"	dark brown	wide	removable spring	n/a	WC468SNS	25	Bulk
6"	white	wide	removable spring	½" x ½"	WC601S	10	Bulk
6"	taupe	wide	removable spring	n/a	WC623S	10	Bulk
6"	black	wide	removable spring	½" x ½"	WC625S	10	Bulk
6"	dark grey	wide	removable spring	½" x ½"	WC628S	10	Bulk
6"	light grey	wide	removable spring	½" x ½"	WC631S	10	Bulk
6"	tan	wide	removable spring	½" x ½"	WC645S	10	Bulk
6"	dark brown	wide	removable spring	½" x ½"	WC668S	10	Bulk
7"	taupe	wide	removable	½" x ½"	WC723	2	Bulk
7"	dark grey	wide	removable	½" x ½"	WC728	2	Bulk
7"	light grey	wide	removable	½" x ½"	WC731	2	Bulk
7"	dark brown	wide	removable	½" x ½"	WC768	2	Bulk
8"	white	wide	removable	½" x ½"	WC801	2	Bulk
8"	taupe	wide	removable	½" x ½"	WC823	2	Bulk
8"	dark grey	wide	removable	½" x ½"	WC828	2	Bulk



WC401SNS

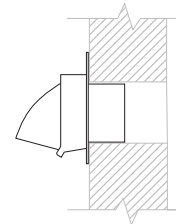

WC768

WCL Wall Cap Low Profile Intake/Exhaust Vent

- UV-stabilized durable polymer resin
- Four removable dampers (for exhaust)
- Screen is not removable
- Made in Canada by Primex

Dia.	Color	Mouth	Flapper	Screen	New PN	Qty	Package
7-8"	white	low profile	4 removable	removable ½" x ½"	WCL701	4	Bulk

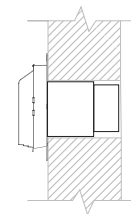

WCL LOW PROFILE



PWM620 Plastic Wide Mouth Hood

- Polypropylene molded plastic
- Fully assembled tailpipe with riveted construction, no caulk
- Four mounting holes

Dia.	Tail Length	Color	Flapper	Each #	Qty	Case #	Package
4"	flush	white	flapper	10766	8	110766	Bulk
4"	flush	white	flapper	10766	392	010768	Skid (gaylord)
4"	flush	brown	flapper	10767	8	110767	Bulk
4"	flush	brown	flapper	10767	392	010769	Skid (gaylord)
3"	1/2" ring	white	flapper	11373	8	111373	Bulk
3"	1/2" ring	brown	flapper	11374	8	111374	Bulk
4"	1/2" ring	white	flapper	10119	8	110119	Bulk
4"	1/2" ring	white	flapper	10119	336	010723	Skid (gaylord)
4"	1/2" ring	brown	flapper	10285	8	110285	Bulk
4"	1/2" ring	brown	flapper	10285	336	010724	Skid (gaylord)
3"	11"	white	flapper	11243	8	111243	Bulk
3"	11"	brown	flapper	11378	8	111378	Bulk
4"	11"	white	flapper	10113	6	010179	Display Tray
4"	11"	white	flapper	10164	8	110164	Display Card
4"	11"	white	flapper	10113	8	110113	Bulk
4"	11"	white	flapper	10330	4	110330	Ind. Box
4"	11"	brown	flapper	10410	8	110410	Display Card
4"	11"	brown	flapper	10177	6	110177	Display Tray
4"	11"	brown	flapper	10284	8	110284	Bulk
4"	11"	brown	flapper	10332	4	110332	Ind. Box
replacement flapper		white		12701	100	112701	Bulk
replacement flapper		brown		12703	100	112703	Bulk



PWM620 4" WHITE

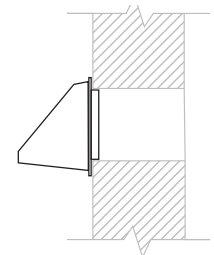

PWM620 WITH 1/2 RING

PWM622 Plastic Wide Mouth Hood with Screen

- Polypropylene molded plastic
 - Fully assembled tailpipe with riveted construction, no caulk
 - Four mounting holes
 - Snap-in removable 1/2" x 1/2" pest grid (Birdguard)
- This hood is not recommended for dryer venting. Check screen frequently for lint build-up.*

Dia.	Tail Length	Color	Flapper	Screen	Each #	Qty	Case #	Package
4"	flush	white	flapper	removable 1/2" x 1/2"	11391	8	111391	Bulk
4"	flush	brown	flapper	removable 1/2" x 1/2"	11392	8	111392	Bulk
3"	1/2" ring	white	flapper	removable 1/2" x 1/2"	11375	8	111375	Bulk
3"	1/2" ring	brown	flapper	removable 1/2" x 1/2"	11376	8	111376	Bulk
4"	1/2" ring	white	flapper	removable 1/2" x 1/2"	11732	8	111732	Bulk
4"	1/2" ring	brown	flapper	removable 1/2" x 1/2"	11733	8	111733	Bulk
3"	11"	white	flapper	removable 1/2" x 1/2"	11365	8	111365	Bulk
3"	11"	brown	flapper	removable 1/2" x 1/2"	11368	8	111368	Bulk
4"	11"	white	flapper	removable 1/2" x 1/2"	11381	8	111381	Bulk
4"	11"	white	flapper	removable 1/2" x 1/2"	11411	6	111411	Display Tray
4"	11"	brown	flapper	removable 1/2" x 1/2"	11384	8	111384	Bulk
replacement grid		white			12700	100	112700	Bulk
replacement grid		brown			12702	100	112702	Bulk



PWM622 FLUSH WITH SCREEN



PWM622 WITH SCREEN

Universal Pest Guard

- Universal cap fits over most wall vent hood
- Hinge action allows for easy cleaning
- Made in Canada

Color	Each #	Qty	Case #	Package
white	11572	12	111572	Bulk
white	11573	12	111573	display label



PML320 Louvered Hood

- Polypropylene molded plastic with freeswinging louvers
- Hoods with 11" tails include aluminum trim plates

Dia.	Tail	Color	# Louvers	Each#	Qty	Case #	Package	UPC
3"	flush	white	4	11149	24	111149	Bulk	
3"	flush	brown	4	11151	24	111151	Bulk	
4"	flush	white	4	11153	24	111153	Bulk	
4"	flush	brown	4	11155	24	111155	Bulk	
5"	flush	white	2	10832	12	110832	Bulk	
5"	flush	brown	2	10836	12	110836	Bulk	
6"	flush	white	3	10840	12	110840	Bulk	
6"	flush	white	3	12310	12	112310	Bulk	•
6"	flush	brown	3	10844	12	110844	Bulk	
6"	flush	brown	3	12311	12	112311	Bulk	•
7"	flush	white	3	10848	12	110848	Bulk	
7"	flush	brown	3	10852	12	110852	Bulk	
8"	flush	white	3	10856	12	110856	Bulk	
8"	flush	brown	3	10860	12	110860	Bulk	
3"	snap ring	white	4	10749	12	110749	Bulk	
3"	snap ring	brown	4	10872	12	110872	Bulk	
4"	snap ring	white	4	11424	12	111424	Display Card	
4"	snap ring	white	4	10286	12	110286	Bulk	
4"	snap ring	brown	4	11545	12	111545	Display Card	
4"	snap ring	brown	4	10287	12	110287	Bulk	
5"	snap ring	white	2	10830	12	110830	Bulk	
5"	snap ring	brown	2	10834	12	110834	Bulk	
6"	snap ring	white	3	10838	12	110838	Bulk	
6"	snap ring	brown	3	10842	12	110842	Bulk	
7"	snap ring	white	3	10846	12	110846	Bulk	
7"	snap ring	brown	3	10850	12	110850	Bulk	
8"	snap ring	white	3	10854	12	110854	Bulk	
8"	snap ring	brown	3	10858	12	110858	Bulk	
3"	11"	white	4	10280	12	110280	Bulk	
3"	11"	white	4	10334	4	110334	Ind. Box	
3"	11"	brown	4	10281	12	110281	Bulk	
4"	11"	white	4	11412	12	111412	Display Card	
4"	11"	white	4	10282	12	110282	Bulk	
4"	11"	white	4	10336	4	110336	Ind. Box	
4"	11"	brown	4	11414	12	111414	Display Card	
4"	11"	brown	4	10283	12	110283	Bulk	
4"	11"	brown	4	10338	4	110338	Ind. Box	



4" WHITE FACE

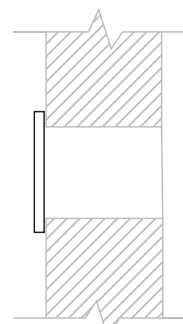

BACK 11153 FLUSH

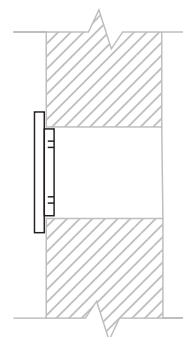

BACK 10286 SNAP-ON RING



11282 4" X 11" WHITE

PML320 Louvered Hood with unassembled tailpipe

- Unassembled tailpipe ships flat, assemble with reeves snap-lock
- Snap-On connecting ring
- Includes aluminum trim plate

Dia.	Tail	Color	# Louvers	Each #	Qty	Case #	Package
4"	snap ring	white	4	11692	12	111692	Bulk
4"	snap ring	brown	4	11734	12	111734	Bulk

Aluminum Tailpipe

- Ships flat, assemble onsite with Reeves Lock

Dia.	Length	Each #	Qty	Case #	Package
3"	11"	10866	24	110866	Bulk
4"	5.5"	12283	75	112283	Bulk
4"	11"	10867	24	110867	Bulk
5"	11"	10862	24	110862	Bulk
6"	11"	10863	24	110863	Bulk
7"	11"	10864	24	110864	Bulk
8"	11"	10865	24	110865	Bulk

- Four tabs
- Designed for the following models:
PWM620, PWM622
PML320, PML324, PML328
- Not for J-Block



PML324 Louvered Hood

- Polypropylene molded plastic with freeswinging louvers and 1/4" x 1/4" grid
- Faceplate only (no tailpipe)



Dia.	Tail	Color	Screen	# Louvers	Each	Qty	Case #	Package
4"	flush	white	1/4"x1/4"	4	10289	24	110289	Bulk
4"	flush	brown	1/4"x1/4"	4	10293	24	110293	Bulk
5"	flush	white	1/4"x1/4"	2	10833	12	110833	Bulk
5"	flush	brown	1/4"x1/4"	2	10837	12	110837	Bulk
6"	flush	white	1/4"x1/4"	3	10841	12	110841	Bulk
6"	flush	brown	1/4"x1/4"	3	10845	12	110845	Bulk
7"	flush	white	1/4"x1/4"	3	10849	12	110849	Bulk
7"	flush	brown	1/4"x1/4"	3	10853	12	110853	Bulk
8"	flush	white	1/4"x1/4"	3	10857	12	110857	Bulk
8"	flush	brown	1/4"x1/4"	3	10861	12	110861	Bulk
3"	snap ring	white	1/4"x1/4"	4	10340	12	110340	Bulk
3"	snap ring	brown	1/4"x1/4"	4	10342	12	110342	Bulk
4"	snap ring	white	1/4"x1/4"	4	10295	12	110295	Bulk
4"	snap ring	brown	1/4"x1/4"	4	10311	12	110311	Bulk
5"	snap ring	white	1/4"x1/4"	2	10831	12	110831	Bulk
5"	snap ring	brown	1/4"x1/4"	2	10835	12	110835	Bulk
6"	snap ring	white	1/4"x1/4"	3	10839	12	110839	Bulk
6"	snap ring	brown	1/4"x1/4"	3	10843	12	110843	Bulk
7"	snap ring	white	1/4"x1/4"	3	10847	12	110847	Bulk
7"	snap ring	brown	1/4"x1/4"	3	10851	12	110851	Bulk
8"	snap ring	white	1/4"x1/4"	3	10855	12	110855	Bulk
8"	snap ring	brown	1/4"x1/4"	3	10859	12	110859	Bulk

PML328 Louvered Hood

- Polypropylene molded plastic
- Freeswinging louvers
- 1/8" x 1/8" wire mesh screen

Dia.	Tail	Color	Screen	# Louvers	Each #	Qty	Case #	Package
4"	flush	White	1/8"x1/8"	4	10291	24	110291	Bulk
4"	flush	Brown	1/8"x1/8"	4	10294	24	110294	Bulk
4"	snap ring	White	1/8"x1/8"	4	10288	12	110288	Bulk
4"	snap ring	Brown	1/8"x1/8"	4	10292	12	110292	Bulk

Louver Replacements

- Snap-in replacement louvers

Color	Each #	Qty	Case #	Package
white	10003	100	110003	Bulk
brown	10004	100	110004	Bulk

J-Block

- Low profile plastic hood for brick, siding & stucco applications
- Weighted flapper design helps prevent wind noise and animal entry
- Snap Ring (flush and 11" tails) • Made in Canada by Duraflou/Canplas

Dia.	Tail	Color	Note	Trim Ring	Flapper	Each #	Qty	Case #	Package
4"	flush	white		Reversible, adjusts from 0 to 1/2"	weighted	11714	12	111714	Bulk
4"	flush	brown		Reversible, adjusts from 0 to 1/2"	weighted	11715	12	111715	Bulk
4"	flush	white		Reversible, adjusts from 1/2" to 1.15"	weighted	11716	12	111716	Bulk
4"	flush	brown		Reversible, adjusts from 1/2" to 1.15"	weighted	11717	12	111717	Bulk
4"	11"	white	unassembled	Reversible, adjusts from 0 to 1/2"	weighted	11705	12	111705	Bulk
4"	11"	brown	unassembled	Reversible, adjusts from 0 to 1/2"	weighted	11712	12	111712	Bulk
4"	11"	white	unassembled	Reversible, adjusts from 1/2" to 1.15"	weighted	11706	12	111706	Bulk
4"	11"	brown	unassembled	Reversible, adjusts from 1/2" to 1.15"	weighted	11713	12	111713	Bulk
4"	11"	silver	Tailpipe	Aluminum tailpipe ships flat, 3 tabs		12421	24	112421	Bulk



34 Accessories

Foil Tape - Model 2158A

- Used to seal connections between Class 0 & Class 1 ducts and air connectors
- UL® Listed 82P4; 181A-P and 181B-FX •Meets HUD & Boca Codes



Description	Each #	Qty	Case #	Package
2.5" wide by 60 yard roll	11704	16	111704	Display Label

Steel Screw Clamps

- 4" Minimum I.D. 3.90", Max 4¼" (1.25" screw) or Max 4.4" (2" screw)
- Galvanized material designed to resist stretching

Dia.	Screw Length	Note	Each #	Qty	Case #	Package
3"	1.25"		10065	100	110065	Bulk
4"	1.25"	2 clamps per card	10074	25	110074	Display Card
4"	1.25"		10071	100	110071	Bulk
6"	1.25"		11417	40	111417	Bulk
4"	2"		10075	100	110075	Bulk

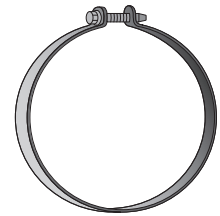

Zip Torq™ Clamps

- Unique polymeric stretch plastic
- Tightens without tools
- Loosens with #2 phillips screwdriver

Dia.	Each #	Qty	Case #	Package
3" - 4"	12145	100	112145	Bulk

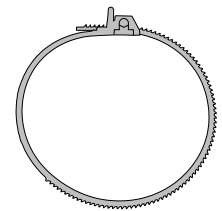

Worm Gear Clamps

- Galvanized
- Plated steel band, housing and screw

Dia.	Note	Each #	Qty	Case #	Package
3"		11908	100	111908	Bulk
4"		11909	100	111909	Bulk
4"	2 clamps per card	11546	25	111546	Display Card
6"		11911	40	111911	Bulk

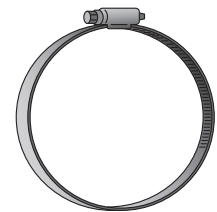

Steel Tension Clamps

- "Spring" clamps
- No tools required

Dia.	Note	Each #	Qty	Case #	Package
3"		10480	100	110480	Bulk
4"	2 clamps per card	11551	25	111551	Display Card
4"		10482	100	110482	Bulk

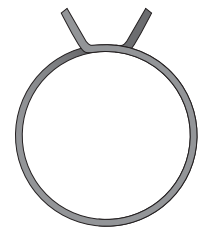

Plastic Cable Tie Clamps

- Releasable Cable Tie
- Press tab, release and reuse.

Dia.	Each #	Qty	Case #	Package
3" - 4"	11423	25	111423	Display Card

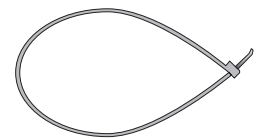

Draft Stopper

- Helps prevent cold air from entering home through clothes dryer by inserting between clothes dryer duct and wall pipe.

Dia.	Each #	Qty	Case #	Package
4"	11577	6	111577	Bulk



Dryer Heat Diverter

- * Manual control directs heat into home in cold weather or outside in warm weather.

Dia.	Each #	Qty	Case #	Package
4"	11575	6	111575	Bulk



Our Story ... at 30 years

In 1990, Builder's Best had a simple mission:
manufacture [The All Metal Solution to Dryer Venting](#).

Easy to install, but a fire hazard, slinky dryer vents were clogging up dryers nationwide. A new way of hooking up clothes dryer venting was needed. Charles Anderson had an idea for venting that could be installed in close quarters and allowed the dryer to be pulled away from the wall without disconnecting the system. His solution was the Snap-Lock™ Pipe and Close Elbows™, which set industry standards for quality, [American manufactured](#) metal venting that did not take a hours to install. Builder's Best quickly gained recognition for its unique solutions, including more elbows and rigid periscopes, redefining efficiency and safety standards.

Today, Builder's Best is run by Charles's son, John, who has expanded the product line to cover 3" to 20" diameter duct, heavy duty through wall hoods and roof caps in galvanized, aluminum and plastic. We are a manufacturer dedicated to American labor and producing reliable venting solutions. Now with over 200,000 square feet in manufacturing and distribution facilities in three states, Texas, Florida and Nevada, Builder's Best enables professional installers and homeowners to solve residential and commercial venting needs quickly and confidently. Our products are [expertly engineered](#) for specific applications to ensure proper airflow between appliances and the exterior of a home.

We created a dryer venting system, [often imitated but never equaled](#). Our products are found coast to coast in retail stores, wholesalers, distributors, installer groups, contractors and appliance manufacturers under several brand names, including our own. Strategic acquisitions and continual investment in all levels of manufacturing and packaging position us as a leader in the industry. We're proud to celebrate 30 years with you!



Builder's Best, Inc.
201 Broiles Drive
Jacksonville, TX 75766
903-586-8283
buildersbest.com

Photo by Mark Krizmanic

Builder's Best, Inc.
201 Broiles
Jacksonville TX 75766

Email:
sales@venting.biz for inquiries

orders@venting.biz for orders

Phone:
903-586-8283

Website:
BuildersBest.com

Builder's Best is committed to manufacturing in America and distributing quality venting solutions for everyone.

Established in 1990, we make quicker and safer ways of venting appliances. As a result, professional installers have relied on our solutions for nearly 30 years.

We've expanded from dryer venting to bathroom fan vents, kitchen vents and roof caps. Our semi-rigid flexible duct is available in 3" thru 24" diameters. Our periscope line of rigid duct covers 0" to 84" lengths. And our rugged, high capacity roof caps out-perform in ASTM B117 testing.

We design, engineer, tool, manufacture, print and package in-house. We ship truckloads nationwide. Our products are carried by wholesalers, distributors and retailers coast to coast.

Situated in the rolling hills of east Texas we are an hour south of Interstate 20, two hours east of Dallas and four hours north of Houston. Our headquarters is in Jacksonville, Texas. We also maintain distribution and manufacturing plants in Jacksonville, Florida and Las Vegas, Nevada.

The All Metal Solution to Dryer Venting™
inVenting solutions™ E-Z-Fasten™
Readi-Pipe™ Econo-Pipe™ Pro-Vent™
ClearDuct™ Snap-Lock™ Zero Periscope™
Umbrella Cap™ Broad Band™ P-Tanium™
and ZipTorq™ are trademarks of Builder's Best, Inc.

Builder's Best® Over-The-Top®
SAF-T-DUCT® Thermofin® T-Fin®
METALFLEX® Nemco®
Close Elbow® Offset Elbow®
and the Builder's Best Logo are registered trademarks of Builder's Best, Inc.

Builder's Best, Inc.

U.S. Patents:

5,121,948; 5,133,579; 5,145,217; 5,158,328; 5,498,204;
5,653,631; 5,819,435; 5,943,743; 6,035,495; 6,370,794;
6,390,510; 7,431,163B2; 20050269243A1; 9,377,141B2;
10,125,899B2; D.335,174; D.342,130; D.342,782 ©

Canadian patents:

2,062,123; 2,063,098; 2,201,956;
2,279,599; 2,299,989; 2,317,863; 2,630,761C; 2,508,954C;
2,857,172C; 2,916,774A1;

and/or patents pending

Western:
North Las Vegas NV 89081

Corporate Headquarters:
201 Broiles Drive
Jacksonville TX 75766

Eastern:
Jacksonville FL 32254



2020
Catalog

V20 for website Interactive 3/23/20